

GENERAL INFORMATION

This booklet is designed to give you the basics which you will need in order to learn the art of improvising in music. Many feel that people who improvise or play jazz are special. If they are special, it is because they have spent their time wisely learning the tools of the trade. A few of the tools are: scales, chords, patterns, licks, songs (standards and originals), training the ear, listening to records of jazz greats and any other thing which they feel will contribute to the growth of a well-rounded musician.

I feel it is good to establish a practice routine, especially for those of you who are new to learning the language of jazz. To play jazz requires discipline, and discipline is good for all of us.

The language of jazz or the jazz idiom is in a constant state of flux. In order to be a part of the jazz movement one must accept change. Jazz has changed greatly over the past 85 years and is presently in transition. Each generation of jazz musicians contribute their own unique ideas, feelings, and sound to the music and this is what creates the change. If you equip yourself well, you may be one of those people who influence others and set new trends in jazz.

If you want to get it all together, I suggest reading each of the pages in this booklet very carefully. Mark with pen or pencil points that you feel are important so when you flip through the pages in the future your eye will catch them. ***Listen, listen, listen*** carefully to anyone playing jazz or improvising. You can learn much from live performances as well as records. Start a record collection and listen to what has been recorded over the past 70 years. You are in for a treat!

Spend your practice time wisely. Don't play things over and over that you can already play. This is great for the ego but does little to advance your musical progress. Be patient with yourself. Don't expect everything to come at one setting. They say that things come to us when we are ready to accept them. A healthy mental state is also responsible for progress when practicing.

Gradually train your ears to really HEAR music and all of the components that make the final product. Read the pages on Ear Training carefully and institute a daily routine to improve your perception. There are also other pages that help spell out an excellent practice routine.

Since most of us do not have a good rhythm section at our disposal, I recommend practicing and soloing with the play-a-long records. Each volume contains a book and one or two recordings. Many professionals use these recordings to warm-up, keep in shape, practice new patterns or licks, or to learn new songs and improvise on the chord/scale progressions.

During the past ten years, many private teachers as well as high school and college teachers have made the recordings part of their daily or weekly teaching assignments. It is good to begin playing with a rhythm section as soon as possible and the better they are the more you can benefit from the experience.

Playing jazz teaches self-esteem and independence.

I also highly recommend our **SUMMER JAZZ WORKSHOPS** which are offered in the U.S. each summer. Some of the finest performers and teachers of jazz appear at these weeklong workshops. Write care of Summer Jazz Workshops, P.O. Box 1244, New Albany, IN 47151-1244, or see our website at <http://www.jazzbooks.com> for more info.

Last but not least, play on the best instrument that you can afford and study with the finest teachers available.

May your journey in music, and jazz in particular, be as enjoyable as it has been for me in putting this booklet together for you.

Jamey Aebersold

VALUABLE JAZZ INFORMATION

by Jamey Aebersold

The basic ingredients in music are SCALES, CHORDS, MELODY, RHYTHM, and HARMONY. Jazz education's purpose is to give you the basics you need in learning to play jazz or to improvise. The jazz musician is an instant composer! The melodies which come from their instruments are conceived in their mind just before they play them. The difference between the improviser and the traditional composer is this: that the "jazzier" has no eraser to instantly correct mistakes. They practice long and hard trying to make their physical body and their mental frame of mind an appropriate vehicle to execute the ideas formulated in their mind.

The GOAL of every jazz musician is to play on their instrument (or vocally sing) what is heard in their mind. Practicing scales, chords (arpeggios), exercises in all keys will help gain facility which will help unlock the ideas that are now being held prisoner in your mind. As soon as possible, try playing what you HEAR mentally in your head! In other words, sing a short melody mentally, or sing with your mouth, and then play those exact pitches and rhythms on your instrument. This is the same procedure the jazz player uses when improvising.

To play requires discipline. It is good to establish a practice routine. Improvisation should be a part of your daily practice. Play whatever you hear in your head. It could be something from TV, radio, or just some melodies that you hum to yourself. This is also a form of EAR TRAINING. You are training your inner ear to direct your fingers to the notes it hears, instantly. Gradually train your ears to really HEAR music and all of the components that make the final product. Listen carefully to anyone playing jazz or improvising. You can learn much from live performances as well as records and tapes. Start a record collection and listen to what has been recorded over the past 70 years. Write for FREE "Double-Time" Jazz discount catalog, P.O. Box 146, Floyds Knobs, IN 47119-0146.

The old myth that says, "You either have it or you don't," is strictly a myth founded on ignorance and the inability (or unwillingness) of those who can play to share what they do verbally with those who think they can't learn.

The mind is the originator of ALL musical thoughts. The mouth (singing) usually can approximate the pitches, rhythms, and nuances of what the mind hears better than actual instruments (sax, trumpet, etc.) can do. Since the instrument we have chosen is a learned device, it is the least able to reproduce the musical thoughts of our mind. It stands to reason that the person who is better equipped technically will come closer to playing on their instrument the thoughts of their mind.

One of the reasons the jazz greats sound different than you is the fact they have so many sounds (scales, chords, patterns, ideas) at their disposal. The SCALE SYLLABUS can help you uncover new sounds. Practicing, using the exercises found in this booklet or in Vol. 1 "How To Play Jazz And Improvise" will give you a good foundation to play ANY style of music.

"JAZZ IS FREEDOM!" Thelonious Monk said this. Too often we refuse to take advantage of an opportunity which will allow us a measure of growth and freedom in our musical expression. Listening to jazz greats is inspirational and rewarding. Keep this in mind: practicing exercises, patterns, licks, scales, and chords should lead to more expressive creativity, not boredom.

HOW DO YOU BEGIN IMPROVISING? Many people begin by playing by ear (letting their inner musical ear guide their choice of notes and rhythms). This is a hit-or-miss process that most jazz players (before 1965) had to use to learn their trade. However, this method strengthens the player's ear and is extremely valuable. Everyone should spend time each day playing by ear. The sooner you train your ears to discern, the sooner they can HELP YOU in making music. By using your ear, and knowledge of the needed scales and chords, you will feel much more comfortable with beginning improvisation.

IMPORTANT: Don't get hung up practicing exercises and more exercises without ever attempting to improvise. Avoid becoming a person who plays great exercises, but delays using their creative energy until tomorrow. DO IT NOW! -- IMPROVISE. Even if you only use a few notes of the scale, begin right there. START! Don't put it off until tomorrow or until you have the scale under better control. DO IT NOW! The longest journey begins with a single step. Today is the first day of the rest of your life. The longest musical phrase begins with a single note.

Just because you practice scales, chords, patterns, and exercises doesn't mean you will sound stiff and mechanical, OR that you will become a jazz great! But it's a means to an end. More than any other ingredient, the JAZZ TRADITION is based on LISTENING. Listening to jazz records/tapes should be part of every musician's daily routine. Not only is it fun to listen to, but you can absorb many musical ideas and incorporate them into your own solos. Recorded music contains most answers you seek.

Having "good ears" means having the ability to hear the roots to the various chords or scales that are being played; having the ability to hear the quality of the chord or scale--major, minor (what kind of minor?), pentatonic, dim.whole tone, etc.); it means having the ability to tell what tone of the scale or chord is being played at any point in the solo--"ah, that note was a #4 resolving to the 6th and then resolving to the 5th!"; it means hearing the piano, bass, soloist, drums, etc. individually as well as collectively.

There are many levels of hearing. Some people hear. Other people can really HEAR! And some can seem to hear and identify almost anything that is being played. They can seem to sing or play back portions of solos right after the performer has played. How can they HEAR, and we can't seem to find the roots, scale, qualities, or what time signature the piece is in? They have worked hard at identifying all the various sounds they hear daily. Since they want to improvise, they take the time to apply on their instrument the things they are hearing. They also use their mind and their free time to figure out things harmonically, melodically, and rhythmically. Using a small chromatic pitch pipe is real helpful in identifying pitches when you are not at a piano or don't have your instrument. You can carry it with you and train your ear "on the go." No one knows or could truly imagine the amount of thought each jazzier has put into their art/craft.

PRACTICE SUGGESTIONS

1. Play with good sound/tone. Wind players -- support your sound. Don't play staccato.
2. Make phrases flow naturally; even when playing scales and exercises.
3. Mentally sing the exercises, scales, patterns as you play them.
4. If an exercise is hard, slow it down. Then gradually increase the tempo.
5. Listen to every note you play. Match your mind's ideas.
6. Be patient. You're not the first to make mistakes.
7. Use jazz articulations on exercises and scale/chord practice.
8. Improvise some every day. That's the REAL YOU. Play what you hear in your head.
9. Make a habit of practicing in all twelve keys. Volumes 21 and 24 are excellent.
10. Learn the Blues in Bb & F concert keys.
11. Memorize everything you can. Know what it is you are trying to play.

If we all waited until we were perfect musicians before we played an instrument, there would be no music in the world. . Play on the best instrument you can afford and study with the finest teachers available who will give you guidance in jazz and traditional music.

Use your imagination. Experiment- take chances! You deserve to be creative! Treat yourself.

Copyright © 2000 Jamey Aebersold Jazz, Inc. <http://www.jazzbooks.com>

Historically Significant Recordings

If you want to learn to play jazz you have to listen, listen, listen. But many times students don't have any idea what recordings to buy. So we have created this list of many of the most important recordings in jazz.

Most of the recordings listed are from the 40's, 50's & 60's Bebop era. This is due to the strong influence this particular period of music has had on our current "Modern Jazz" scene today. We have purposely omitted a number of very early recordings because 1) many of those early recordings had very poor sound quality, 2) the artists recorded lots of material, and so they are represented by later recordings elsewhere on this list, and/or 3) the early recordings are not currently available on CD. If you have a turntable, you should start checking out yard sales and thrift stores—often you can find classic jazz recordings on vinyl for next to nothing.

For each record listed, you can see the artist name followed by the name of the album. All of these recordings are available on CD (at presstime) from "Double-Time Records." The number to the left of each listing (eg—cd #7951) indicates the "Double-Time" catalog number of that CD. Make a copy of this sheet and check off each recording as you add it to your collection. To check on prices, to order, or for a complete catalog of over 6000 jazz CD titles, contact:

"DOUBLE-TIME RECORDS" • PO Box 146 • Floyds Knobs, IN 47119-0146 • PH (800) 293-8528 • FAX (812) 923-1971
<http://www.doubletimejazz.com> • **E-mail: info@doubletimejazz.com**

You may also find many CD's at "TheMusicResource.com"
<http://www.themusicresource.com> • **E-mail: info@themusicresource.com**

___ cd #1	CANNONBALL ADDERLEY - SOMETHIN' ELSE	___ cd #592	RED GARLAND - GROOVY
___ cd #63	HERBIE HANCOCK - MAIDEN VOYAGE	___ cd #1059	MILES DAVIS - STEAMIN' WITH MILES DAVIS
___ cd #350	CLIFFORD BROWN - STUDY IN BROWN	___ cd #59	JOHNNY GRIFFIN - A BLOWIN' SESSION
___ cd #30	JOHN COLTRANE - BLUE TRAIN	___ cd #318	JOHN COLTRANE - BALLADS
___ cd #9958	CANNONBALL ADDERLEY - & COLTRANE	___ cd #912	CARL FONTANA - THE GREAT FONTANA
___ cd #141	WAYNE SHORTER - SPEAK NO EVIL	___ cd #1418	ART BLAKEY - UGETSU
___ cd #1126	HORACE SILVER - SONG FOR MY FATHER	___ cd #6	ART BLAKEY - A NIGHT AT BIRDLAND VOL. 2
___ cd #7948	DIZZY GILLESPIE - SONNY SIDE UP	___ cd #1738	FREDDIE HUBBARD - HUB TONES
___ cd #458	MILES DAVIS - KIND OF BLUE	___ cd #3683	BUD POWELL - THE GENIUS OF
___ cd #417	JOHN COLTRANE - GIANT STEPS	___ cd #9974	MILES DAVIS - BITCHES BREW
___ cd #1716	J. J. JOHNSON - THE EMINENT, VOLUME 1	___ cd #8015	JOHN COLTRANE - THE COMPLETE VANGUARD SESSIONS
___ cd #33	ERIC DOLPHY - OUT TO LUNCH	___ cd #2450	LEE KONITZ - SUBCONSCIOUS-LEE
___ cd #340	OLIVER NELSON - BLUES & THE ABSTRACT TRUTH	___ cd #3612	STAN GETZ - STAN GETZ & BILL EVANS
___ cd #1820	LEE MORGAN - THE SIDEWINDER	___ cd #588	MILT JACKSON - BAGS MEETS WES
___ cd #97	HANK MOBLEY - SOUL STATION	___ cd #154	JIMMY SMITH - BACK AT THE CHICKEN SHACK
___ cd #463	MILES DAVIS - MILESTONES	___ cd #596	SONNY ROLLINS - PLUS FOUR
___ cd #3805	WES MONTGOMERY - SMOKIN AT THE HALF NOTE	___ cd #1753	JOE HENDERSON - INNER URGE
___ cd #109	LEE MORGAN - CORNBREAD	___ cd #80	WOODY HERMAN - KEEPER OF THE FLAME
___ cd #9653	LARRY YOUNG - UNITY	___ cd #2607	BUD POWELL - THE AMAZING - VOL 1
___ cd #601	SONNY ROLLINS - SAXOPHONE COLOSSUS	___ cd #3745	CLIFFORD BROWN - BROWN/ROACH INC.
___ cd #421	JOHN COLTRANE - MAINSTREAM 1958	___ cd #68	JOE HENDERSON - MODE FOR JOE
___ cd #172	MCCOY TYNER - THE REAL MCCOY	___ cd #149	HORACE SILVER - BLOWIN' THE BLUES AWAY
___ cd #316	JOHN COLTRANE - A LOVE SUPREME	___ cd #678	CLIFFORD BROWN - MORE STUDY IN BROWN
___ cd #2434	DIZZY GILLESPIE - JAZZ AT MASSEY HALL	___ cd #27	SONNY CLARK - LEAPIN' AND LOPIN'
___ cd #5	ART BLAKEY - A NIGHT AT BIRDLAND VOL. 1	___ cd #5600	MILES DAVIS - MY FUNNY VALENTINE
___ cd #45	BILL EVANS - UNDERCURRENT	___ cd #3748	CHICK COREA - LIGHT AS A FEATHER
___ cd #3523	GENE AMMONS - BOSS TENORS	___ cd #62	HERBIE HANCOCK - EMPYREAN ISLES
___ cd #460	MILES DAVIS - 'ROUND ABOUT MIDNIGHT	___ cd #1336	SONNY ROLLINS - NEWK'S TIME
___ cd #471	ERROLL GARNER - CONCERT BY THE SEA	___ cd #1952	HORACE SILVER - CAPE VERDEAN BLUES
___ cd #578	MILES DAVIS - RELAXIN' WITH MILES	___ cd #4318	HERBIE HANCOCK - THE PRISONER
___ cd #538	WES MONTGOMERY - INCREDIBLE JAZZ GUITAR	___ cd #5601	MILES DAVIS - SEVEN STEPS TO HEAVEN
___ cd #67	JOE HENDERSON - PAGE ONE	___ cd #2683	BILLIE HOLIDAY - LADY DAY: BEST OF VERVE YRS
___ cd #2377	FRANK ROSOLINO - FREE FOR ALL	___ cd #3922	CHARLES MINGUS - MINGUS AH UM
___ cd #557	WES MONTGOMERY - FULL HOUSE	___ cd #2210	DEXTER GORDON - HOMECOMING, LIVE AT V.V.
___ cd #2562	ART FARMER - MODERN ART	___ cd #8	ART BLAKEY - THE BIG BEAT
___ cd #558	SONNY ROLLINS - TENOR MADNESS	___ cd #1038	CANNONBALL ADDERLEY - IN SAN FRANCISCO
___ cd #7	ART BLAKEY - MOANIN'	___ cd #9922	MILES DAVIS - MILES SMILES
___ cd #459	MILES DAVIS - IN A SILENT WAY	___ cd #7458	JOHN COLTRANE - LIVE AT BIRDLAND
___ cd #541	THELONIOUS MONK - WITH JOHN COLTRANE	___ cd #588	MILT JACKSON - BAGS MEETS WES
___ cd #31	CHICK COREA - NOW HE SINGS, NOW HE SOBS	___ cd #8302	FREDDIE HUBBARD - STRAIGHT LIFE
___ cd #560	BILL EVANS - SUNDAY AT VILLAGE VANGUARD	___ cd #597	MILES DAVIS - BAG'S GROOVE
___ cd #3806	CHARLIE PARKER - NOW'S THE TIME	___ cd #413	ORNETTE COLEMAN - SHAPE OF JAZZ TO COME
___ cd #3605	STAN GETZ - FOR MUSICIAN'S ONLY	___ cd #5321	STANLEY TURRENTINE - UP AT MINTON'S
___ cd #7951	CHARLIE PARKER - BIRD & DIZ	___ cd #418	JOHN COLTRANE - MY FAVORITE THINGS
___ cd #3019	JOE HENDERSON - LUSH LIFE, STRAYHORN MUSIC	___ cd #1271	MILES DAVIS - NEFERTITI
___ cd #583	BILL EVANS - WALTZ FOR DEBBY	___ cd #12704	WOODY SHAW - LITTLE RED'S FANTASY
___ cd #9999	KENNY DORHAM - UNA MAS	___ cd #44	ELLINGTON, MINGUS, ROACH - MONEY JUNGLE
___ cd #7946	LESTER YOUNG - THE PRESIDENT PLAYS W/THE OSCAR PETERSON TRIO	___ cd #5092	DIZZY GILLESPIE - ROY AND DIZ
___ cd #5436	JOE HENDERSON - IN 'N OUT	___ cd #7854	BENNY CARTER - FURTHER DEFINITIONS
___ cd #322	JOHN COLTRANE - & JOHNNY HARTMAN	___ cd #3930	JOHNNY GRIFFIN - TOUGH TENOR FAVORITES
___ cd #5433	NANCY WILSON - WITH C. ADDERLEY	___ cd #5443	COUNT BASIE - THE COMPLETE ATOMIC BASIE
___ cd #559	MILES DAVIS - COOKIN'		

Soloing: by Jamey Aebersold

1. Keep your place - don't get lost. If you do get lost LISTEN to the rhythm section. The drummer will often give a little crash at the beginning of new sections. If you hit a note that is not what you intended, move it up or down a half-step and you'll probably be back in the scale (or chord). Remember, jazz music usually moves in two, four and eight bar phrases. You're never far from a new phrase beginning.

2. Play right notes. This really means play the notes you hear in your head...the notes you would sing with your mouth. Having the scales and chords in front of you on a piece of paper is merely a guide. They don't provide the actual music that's going to be played. THAT comes from YOUR imagination. If you've got the scales, chords, and chord/scale progression MEMORIZED it provides courage to your imagination and allows you to operate from a more creative natural basis. It allows you to take some chances. It helps remove FEAR.

3. Using REPETITION and SEQUENCE is natural in music. It's found in all types and styles of music. The novice improviser often feels that if they repeat an idea, everyone knows they are going to repeat it, so why do it; plus it's not original enough for your EGO so you don't play it. WRONG! The listener needs to hear some repetition and sequence or else they can't remember anything you play. Repetition and Sequence are the glue that holds solos together. The usual number of times something is repeated depends on you but the average is 2 or 3 and then your mind will tell you when to repeat and/or when to use sequence. It's a part of the way we hear music played by others.

4. CHORD TONES (the 1, 3, 5, & 7 of a scale) are great notes to begin and end a phrase with. Just sing a phrase and see if you don't follow this simple rule. Our ears HEAR chord tones first so it's natural to begin and end there. Plus, it gives us and the listener what we're listening for - *harmonic stability*.

5. SOUND: Be sure that you are getting a good, full sound on your instrument (or voice). Don't let the scales and chords or the progression or tempo intimidate you. Sound is foremost and is the FIRST thing a person latches onto when you sing or play. It leaves a lasting impression. So, be yourself and let your voice or instrument ring out. It's the main ingredient of your musical personality.

6. LISTENING: There's no way anyone is going to play jazz or improvise well without **listening** to those musicians who have come before. Through listening alone you can find ALL the answers. Each musician is a result of what they have listened to. It's easy to determine who people have listened to by listening to them play. We all tend to use imitation and it's good to do this. Some feel that if they listen to others they'll just sound like them. This is not true but your ego will try to convince you it's true. The ego hates competition or what it perceives to be competition. Don't let it fool you. If no one listened to anyone else, why play music? Music is for everyone and truly is a Universal Language.

7. Everyone has the ability to improvise - from the youngest child to the senior citizen. You have to have desire and set aside time to work at it until moving your fingers becomes automatic and the distance between your mind and fingers grows smaller and smaller to where you think an idea and your fingers are already playing it. It's not magic. If it is, then magic equals hard work and perseverance. When asked, "What is the greatest obstacle to enlightenment?" the Buddha replied, "Laziness." *I agree!*

JAZZ: THE NATURAL MUSIC

Improvising, playing jazz, is the most natural way to make music. Long before the printing press was invented people played music on various instruments and all were thought to be creative musicians. Through the ages the art of improvising on a musical instrument gradually lost favor to the printed page. In the twentieth century the art of improvising has been kept alive by the jazz musician.

Today's jazzer is not the same as the musician of the thirties, forties or fifties. The influence of jazz education, sound recordings, videos and jazz festivals has allowed the music to reach many more people and to be experienced by almost anyone who is willing to give it a try.

For years the myth "you either have it or you don't" was prevalent in music circles around the world. If you wanted to play jazz you had better get adopted into a musical family or by the "luck of the draw" find the right environment for your early years so by osmosis you could pick up on the hot licks and at the same time develop a great jazz ear so that when you played your instrument, you would sound like a jazzer.

Time has proven that these ideas which were very popular are not true. They never were true but many musicians thought they were and that's what gives an idea it's longevity. Once people from non-musical backgrounds in non-jazzy environments began playing the music and playing it well, everyone had to take another look at what goes on when someone stands up and improvises a good solo over a standard chord progression such as *Green Dolphin Street*, *Confirmation*, or the blues.

Here are several ingredients that go into making a good jazz soloist/improviser:

1. Desire to improvise
2. Serious listening to jazz via recordings and live performances
3. A method of practice - what and how to practice!
4. A rhythm section with which to practice and improvise (via live group or play-a-long recordings)
5. Self-esteem, discipline, and determination.

When I was a teenager, I wondered if I'd ever be able to play on my instrument the melodies I was hearing in my head. I didn't have a jazz teacher so I would listen to the radio or records and try to take off the ideas of the jazz greats such as Coleman Hawkins, Charlie Parker, Dizzy Gillespie, Sonny Stitt, Sonny Rollins and many others. If I were to start again here's how I would do it:

I would begin by playing on my instrument simple little melodies such as *Happy Birthday*, *Twinkle, Twinkle Little Star*, and *Row, Row, Row Your Boat*. I would pick a note in my middle register say, G#, and begin playing one of these songs. When I finally played it correctly ONE time, I would pick a new starting note say, Eb and play the same song beginning on that note. Do this over and over beginning on different tones until you can play the song starting on different notes without mistakes. Then try a different song and get so you can play it starting on any of the twelve notes of the chromatic scale. This is an excellent way of conditioning your fingers and mind to work together to produce the sounds you are hearing in your head. It shortens the distance from mind to fingers.

Jazz musicians have always played the music of their mind—what they hear in their head. They aren't special, gifted people who were born with more talent than others. They just had more desire and discipline than others. Their ability to mentally hear an idea and then play it comes from practice.

When you run out of ideas to practice you listen to other musicians. The joy of listening to others, coupled with your imagination, will lead to fresh musical ideas. The answer to every musical question may be found on recordings. That is why listening is so important for the beginning improviser.

Usually, we begin improvising on songs like blues in Bb or F, *Satin Doll*, *Maiden Voyage*, or *Summertime*. Songs like these don't contain tricky rhythms or difficult harmony (scales and chords). This makes it easier to make sense of the song and feel relatively good about improvising over the harmony. These songs (and many more) are on the Vol. 54 "Maiden Voyage" play-a-long.

Here are several exercises every professional jazz musician has probably played at one time or another. Play these over the harmony (changes, chord/scales) to whatever song you are working on. Do this before you try to improvise.

1. Play the first five notes to each chord/scale.
2. Play the triad (notes 1,3, and 5 of the scale).
3. Play the entire scale from the root (first note) to the 9th and back down.
4. Play the 7th chord up and down (1,3,5,7,5,3,1).
5. Play the 9th chord up and down (1,3,5,7,9,7,5,3,1).
6. Play the scale up to the 9th and then come back down the **chord**.
7. Play the chord up to the 9th and then come back down the **scale**.
8. Play the scale in thirds up and down.

If you were to take numbers 1, 2, and 3 from above and apply them to the first four bars of an F blues, it would look like this:

The image shows three staves of musical notation in 4/4 time, illustrating a blues scale exercise. The first staff shows a sequence of notes: F4, G4, A4, Bb4, C5, D5, E5, F5, with a chord symbol F7 above the first bar and Bb7 above the second bar. The second staff shows a similar sequence: F4, G4, A4, Bb4, C5, D5, E5, F5, with a chord symbol F7 above the first bar and Bb7 above the second bar. The third staff shows a sequence of notes: F4, G4, A4, Bb4, C5, D5, E5, F5, with a chord symbol F7 above the first bar and Bb7 above the second bar. Each staff ends with 'ETC.' indicating the exercise continues.

I once heard trumpeter Woody Shaw warming up before a concert in the above manner. It impressed me because I thought only beginners used this type warm-up. After thinking about it, I realized it was the most practical way to approach any new song. When you do this you are conditioning your mind and fingers to the scales and chords which you will in turn improvise over. It makes good sense!

You should be able to do this to the chord/scale progression to any song you are going to improvise over. This is standard practice and has been for some time...know your scales and chords before you play. Memorize them, too! Memorizing melodies, scales and chords gives courage to your imagination.

Now, some will feel that to play jazz, you don't study or practice scales and exercises, "you just play." I ask, what does that mean? Who can "just play" over *Giant Steps*, *Tune Up*, *Confirmation*, *Star Eyes*, the blues or a thousand other tunes with interesting chord progressions? The famous alto saxophonist Charlie Parker in his own words said there was a period of 3 to 4 years where he practiced 11 to 15 hours a day. If Charlie Parker was, as many say, a genius, he got that way by practicing. I have a recording of him saying this in an interview with Paul Desmond. I also have a recording of him saying at age 16 (after having gotten laughed off the bandstand for not knowing you're suppose to play the same song the band is playing!), "I never stopped to think about there being other keys or nothin' like that." So, he began like most of us but eventually discovered that HE was master of his own ship. He took the bull by the horns and dove into the marvelous world of jazz—the world of improvisation, harmony, rhythm, melody, creativity, imagination and life.

If you've ever wondered why teachers begin students with fingerings, tone production (wind instruments) and scales, I feel it's to form a strong foundation for the students' creativity. Your instrument reflects your musical personality.

Transcribing solos or portions of solos off recordings is one of the best ways to find out what the professional is doing to make things sound so good. By analyzing a solo you can find important facts:

1. What note of the scale do they begin phrases with?
2. What note of the scale do they end their phrases with?
3. Do they use a wide or narrow range, (tessitura)?
4. Do they use chord tones in their phrases?
5. Do they use scales or bits and pieces of scales?
6. Do they have favorite licks that pop up over and over?
7. Do they use chromatics (notes outside the basic chord/scale)?
8. Do they use passing tones?
9. Repetition: do they use it and how...rhythmically, melodically, harmonically?
10. Do they use space, rests, silence? How often? Is there a pattern?
11. Do they build their solo? Does the solo seem to tell a story or go somewhere?
12. Do they tend to place chord tones (1,3,5) on beats 1 and 3 (in 4/4 time).
13. Do they incorporate substitute scales over the basic chord/scales?
14. Do they double-time any phrases (this usually means playing in 16th notes)?
15. Do they use the blues scale? How often?
16. Do they use sequences in their playing?

Having spent over 35 years working with musicians of all levels, I find that one of the fundamental needs is to express themselves in an improvisatory manner on their instrument. Playing jazz, in this century, has been the route those musicians have taken.

Creativity and use of imagination is essential to our well-being as humans on the planet Earth. We are creative beings. With a little guidance everyone can learn to improvise and enjoy the fruits of self-expression in music. There's really nothing to be afraid of. Life is exactly what you make it to be. -- **by JAMEY AEBERSOLD**

SUGGESTED LISTENING—JAZZ ARTISTS

1. TRUMPET

Freddie Hubbard, Clifford Brown, Miles Davis, Dizzy Gillespie, Woody Shaw, Lee Morgan, Blue Mitchell, Clark Terry, Kenny Dorham, Roy Eldridge, Don Cherry, Fats Navarro, Johnny Coles, Chet Baker, Virgil Jones, John McNeil, Tom Harrell, Wynton Marsalis, Terumasa Hino, Wallace Roney, Phillip Harper, Scott Wendholt, Roy Hargrove, Bobby Shew, Kevin Dean, Art Farmer, Tim Hagens, Barry Ries, Harry Edison, Buck Clayton, Booker Little, Thad Jones, Nat Adderley, John Swana, Nicholas Payton, Kenny Wheeler, Joe Magnarelli

2. ALTO SAX

Charlie Parker, Sonny Stitt, Lou Donaldson, Phil Woods, Cannonball Adderley, Charlie Mariano, Lee Konitz, Paul Desmond, Jackie McLean, Ornette Coleman, Roscoe Mitchell, Eric Dolphy, Herb Geller, Art Pepper, Lennie Niehaus, Bud Shank, Lanny Morgan, Richie Cole, Eric Kloss, Bunky Green, Bobby Watson, Kenny Garrett, Greg Osby, Frank Morgan, John Jenkins, Jim Snidero, Paquito D'Rivera, James Spaulding, Gary Bartz, Arthur Blythe, Steve Coleman, Steve Wilson, Craig Bailey, Jimmy Greene

3. TENOR SAX

Lester Young, Walt Weiskopf, Coleman Hawkins, Stan Getz, John Coltrane, Sonny Rollins, Gene Ammons, Joe Henderson, Wayne Shorter, George Coleman, Harold Land, Azar Lawrence, Dewey Redman, Steve Grossman, John Klemmer, Dave Liebman, Pharoah Sanders, Ben Webster, Benny Golson, Dexter Gordon, Wayne Marsh, Zoot Sims, Charles Lloyd, Hank Mobley, Sonny Stitt, Bob Berg, Billy Pierce, Joe Farrell, Mike Brecker, Archie Shepp, Bud Freeman, Von Freeman, Chico Freeman, Clifford Jordan, Rick Margitza, Branford Marsalis, Larry Schneider, Bill Evans, Joe Lovano, Eric Alexander, James Moody, Don Braden, Joshua Redman, Gary Campbell, Ralph Lalama, Illinois Jacquet, Paul Gonsalves, Eddie "Lockjaw" Davis, Johnny Griffin, Stan Turrentine, George Adams, Chris Potter, George Garzone, Jerry Bergonzi, Benny Wallace, Bob Mintzer

4. BARITONE SAX

Gerry Mulligan, Pepper Adams, Harry Carney, Sahib Shihab, Serge Chaloff, Leo Parker, Charles Davis, Pat Patrick, Ronnie Cuber, Nick Brignola, Gary Smulyan

5. TROMBONE

Milt Bernhardt, Jimmy Cleveland, Jack Teagarden, Bill Harris, Phil Wilson, J.J. Johnson, Kai Winding, Frank Rosolino, Carl Fontana, Curtis Fuller, Grachan Moncur, Garnett Brown, Bill Watrous, Roswell Rudd, Steve Turre, Robin Eubanks, Hal Crook, Urbie Green, Conrad Herwig, John Fedchock, Ray Anderson, Steve Davis

6. FLUTE

Hubert Laws, James Moody, Herbie Mann, Frank Wess, Jeremy Steig, Roland Kirk, Yusef Lateef, David Liebman, Eric Dolphy, Joe Farrell

7. CLARINET

Benny Goodman, Artie Shaw, Tony Scott, Buddy DeFranco, Woody Herman, Pee Wee Russell, Jimmy Guiffre, Eric Dolphy (bass clarinet), Russell Procope, Eddie Daniels, Paquito D'Rivera, Phil Woods, Art Pepper, John Carter

8. GUITAR

Charlie Christian, Django Reinhardt, Wes Montgomery, Kenny Burrell, Barney Kessel, Herb Ellis, Joe Pass, Jim Hall, Tal Farlow, Attila Zoller, Pat Martino, Mick Goodrick, Larry Coryell, John McLaughlin, Grant Green, George Benson, Jerry Hahn, Jimmy Raney, Doug Raney, Emily Remler, Earl Klugh, Peter Bernstein, Steve Erquiaga, Peter Leich, Vic Juris, Joshua Breakstone, Chris Flory, Joe Cohn, Scott Henderson, Dave Cliff, Howard Alden, Pat Metheny, Dave Stryker, John Scofield, Bill Frisell, Charlie Hunter, Mike Stern

9. PIANO

Bill Evans, Chick Corea, Herbie Hancock, Oscar Peterson, Lennie Tristano, Mulgrew Miller, James Williams, Mary Lou Williams, Thelonius Monk, Hampton Hawes, Roland Hanna, Al Haig, Art Tatum, Oscar Peterson, Joe Zawinul, Victor Feldman, McCoy Tyner, Keith Jarrett, Paul Bley, Wynton Kelly, Red Garland, George Cables, George Duke, Denny Zeitlin, Bud Powell, Phineas Newborn Jr., Ahmad Jamal, Kenny Drew, Tommy Flanagan, Horace Silver, Kenny Barron, John Lewis, Michel Petrucciani, Ronnie Mathews, Makoto Ozone, Michel Camilo, Cedar Walton, Hal Galper, Larry Goldings, Benny Green, Lynne Arriale, Mike LeDonne, Dan Haerle, Mark Levine, Dave Brubeck, Andy LaVerne, Harry Pickens, Kenny Werner, Erroll Garner, Hank Jones, Ray Bryant, Bobby Timmons, Harold Mabern, Andrew Hill, Geri Allen, Joey Calderazzo, Danilo Perez, Brad Meldhau, Jacky Terrasson, Gonzalo Rubalcaba, Geoff Keezer, Benny Green, Bruce Barth

10. BASS

Ray Brown, Scott LaFaro, Oscar Pettiford, Charlie Mingus, Paul Chambers, Richard Davis, Ron Carter, Rufus Reid, Eddie Gomez, Monk Montgomery, Chuck Rainey, Miroslav Vitous, George Mraz, Stanley Clarke, Bob Cranshaw, Jimmy Garrison, Percy Heath, Steve Swallow, Buster Williams, Cecil McBee, Jimmy Blanton, Red Mitchell, Mike Moore, Sam Jones, Israel Crosby, Jaco Pastorius, Milt Hinton, Slam Stewart, George Duvivier, Todd Coolman, Larry Grenadier, John Patitucci, Lynn Seaton, Bill Moring, Denis Irwin, John Goldsby, Kenny Washington, Peter Washington, Christian McBride, Bob Hurst, Charles Fambrough

11. DRUMS

Elvin Jones, Max Roach, Tony Williams, Philly Joe Jones, Kenny Clarke, Art Blakey, Connie Kay, Jack DeJohnette, Roy Haynes, Paul Motian, Billy Higgins, Billy Cobham, Louis Bellson, Buddy Rich, Grady Tate, Micky Roker, Ed Blackwell, Bobby Moses, Joe Chambers, Alphonse Mouzon, Shelly Manne, Stan Levy, Danny Richmond, Billy Hart, Lenny White, Al Foster, Ed Soph, Terri Lyne Carrington, Steve Davis, Peter Washington, Bill Stewart, Billy Drummond, Art Taylor, Jimmy Cobb, Tootie Heath, Roger Humphries, Roy Brooks, Idris Muhammed, Kenny Washington, Jeff "Tain" Watts, Marvin "Smitty" Smith, Ralph Peterson, Joey Baron, Dave Weckl, Brian Blade, Joe Farnsworth, Adam Nussbaum, Tony Reedus

12. VIBES

Milt Jackson, Gary Burton, Dave Friedman, David Samuels, Roy Ayers, Lynn Blessing, Lionel Hampton, Red Norvo, Bobby Hutcherson, Steve Nelson, Cal Tjader, Terry Gibbs, Dave Pike, Jay Hoggard, Stephen Harris, Joe Locke

13. ORGAN

Jimmy Smith, Larry Young, Jack McDuff, Richard "Groove" Holmes, Jimmy McGriff, John Patton, Hank Marr, Larry Goldings, Mike Ladonne, Charles Earland, Joey DeFrancesco, Barbara Dennerlein

14. BIG BANDS

Duke Ellington, Count Basie, Woody Herman, Stan Kenton, Buddy Rich, Don Ellis, Gerald Wilson, Thad Jones-Mel Lewis, Bill Watrous, Francy Boland, Louis Bellson, Gil Evans, Rob McConnell, Maynard Ferguson, Bob Mintzer, Airmen Of Note, Bill Holman, Bob Florence, Dizzy Gillespie, Charles Mingus, George Russell, Maria Schneider, Sun Ra, Toshiko Akiyoshi, Lew Tabackin, Mingus Dynasty Big Band, Bob Mintzer, Conrad Herwig's Latin Big Band, Randy Weston, Tito Puente, Eddie Palmieri, Carla Bley, Monday Night Vanguard Orchestra, Wynton Marsalis,

15. VOCALISTS

Jon Lucien, Roy Kral, Frank Sinatra, Mel Torme, Lou Rawles, Ray Charles, Mose Allison, Billy Eckstine, Leon Thomas, Grady Tate, Joe Williams, Sarah Vaughn, Carmen McCrae, Peggy Lee, Rosemary Clooney, Billie Holiday, Ella Fitzgerald, Jackie Cain, Dakota Staton, Johnny Hartman, Chris Connor, June Christy, Anita O'Day, Betty Carter, Chet Baker, Dinah Washington, Eddie Jefferson, Diana Krall, Kevin Mahogany

16. SCAT SINGERS

Clark Terry, Denis DiBlasio, Chet Baker, Louis Armstrong, Dizzy Gillespie, Ella Fitzgerald

17. VIOLIN

Joe Venuti, Stuff Smith, Ray Nance, Jean-Luc Ponty, Stephane Grappelli, Michael White, Jerry Goodman, John Blake, Randy Sabien, Fiddler Williams, Joe Kennedy Jr., Darol Anger

THE DOMINANT 7th TREE of SCALE CHOICES

The two most important notes in any scale are the 3rd and 7th. They tell the listener what the quality is and indicate the harmonic motion. The **3rd** tells us if it's major or minor. The **7th** tells whether the sound is stable (doesn't want to move to another chord) or if it wants to move on to a chord of resolution. Dominants typically want to resolve to a chord up a perfect 4th (C7 wants to resolve to F, F-, F7 etc.). The **root** or tonic is taken for granted. If it wasn't there we wouldn't be able to identify the sound.

Any of these scales (qualities/sounds/sonorities) may be played when a dominant 7th chord/scale RESOLVES to a chord/scale whose ROOT lies a perfect 4th (5 half-steps) above the root of the dominant 7th chord.

EXAMPLE: || C7 | C7 | F | F | Ab7 | Ab7 | Db- | Db- ||
Embellish the measures with these chords: C7 and Ab7

The altered tones are in **bold type**. Those tones usually resolve by *half-step* to a scale or chord tone. This amounts to **tension then release**. It's a natural occurrence in music. The 3rd's and 7th's are underlined.

SCALES

- 1. DOM.7th** = C7 = C D E F G A Bb C
This is the basic dominant 7th sound. Be careful how you treat the 4th tone. Use it as a passing tone.
- 2. BEBOP** = C7 = C D E F G A Bb B C
Play B natural as a passing tone. It should always appear on an upbeat never on the downbeat.
- 3. LYDIAN DOM.** = C7#4 = C D E **F#** G A Bb C
The #4 was/is a favorite note. It used to be called a b5.
- 4. WHOLE-TONE** = C7+ = C D E **F#** **G#** Bb C
This scale only has 6 tones. It is a symmetrical scale used often in cartoon music and by DeBussy and Ravel. **[Has a #4 and #5]**
- 5. DIMINISHED** = C7b9 = C **Db** **D#** E **F#** G A Bb C
This scale has 8 different tones. It is symmetrical and is also used in cartoon music. Michael Brecker is a master of this scale sound. **[Has a b9, #9 and #4]**
- 6. DIM. WHOLE-TONE** = C7+9 = C **Db** **D#** E **F#** **G#** Bb C
This scale has four altered tones which help create tension. **[Has a b9, #9, #4 and #5]**
- 7. SPANISH or JEWISH SCALE** = C7 (b9) = C **Db** E F G **Ab** Bb C
This scale is used often when playing in a minor key. It's the same as F harmonic minor. **[Has a b9 and b6]**
- 8. CHROMATIC SCALE** = C7 = C **C#** D **D#** E F **F#** G **G#** A **A#** B C
(the Musical Alphabet) C **Db** D **Eb** E F **Gb** G **Ab** A **Bb** B C

Any time there is a dominant 7th, you may want to experiment with these scales. The proper use of these various scales is part of what makes jazz so appealing. Endless variety in the hands of a master makes beautiful music. Don't be afraid to try these sounds. It may take some time for your ears to become accustomed to the sound and the fingerings. The book called *Patterns For Jazz* (Aebersold product code "P-T" for treble clef instruments, "P-B" for bass clef) lists jazz phrases based on many of the scales above.

PRACTICE PROCEDURE FOR MEMORIZING SCALES AND CHORDS TO ANY SONG

by Jamey Aebersold

The eight exercises listed below represent the typical jazz approach to learning the basic harmony for the blues in Bb. You'll want to vary the rhythms to add variety and make them sound more improvised. You can use this approach for learning ANY scale or chord to ANY song. This Bb blues progression is taken from the Vol.42 "BLUES" IN ALL KEYS play-4-long book/recording set.

As you play, memorize the chord/scale progression as well as the chord and scale tones. After playing through these eight choruses, I think you'll be surprised how easy it is to memorize. Concentrate on the SOUND of each note.

Think of the blues progression as being three four-bar sections. It has a beginning (4-bars), a middle section (4-bars), and an ending (4-bars). After you become familiar with various scales and chords you won't need to go through this practice procedure when working on a new tune. You'll already have the needed scales and chords memorized. This is what the professional jazz musician has done. Commit to memory and enjoy making music. Remember, the purpose of any exercise is to help you truly MAKE MUSIC.

5 Triads

6 7th Chords

7 9th Chords

8 Entire Scale

1 ROOTS

2 1st & 2nd Notes

3 First 3 Notes

4 First 5 Notes

SONG LIST for BEGINNERS

Here are songs which everyone should eventually know—they are good jam session songs. I am listing the key(s) they are most often played in followed in parenthesis by the play-a-long volume number(s) where you can find them. Most of the beginning songs are on the Volume 54 “Maiden Voyage” play-a-long book/recording set. It's excellent for learning jam session tunes.

Beginning Songs

Blues in Bb & F (1, 2, 21, 35, 42, 50, 53, 54, 69, 70, 73)
Footprints, C- (33, 54)
Satin Doll, C (12, 54, 66)
Doxy, Bb (8, 54)
Autumn Leaves, G- (20, 44, 54, 67)
Impressions or So What, D- (28, 50, 54)
Summertime, D- (25, 54)
Song For My Father, F- (17, 54)
Maiden Voyage, A- (11, 54, 8 1)
Silers Serenade, E- (17)
Cantaloupe Island, F- (11, 54)
Sugar, C- (5, 49, 70) (called Groovitis)
Watermelon Man, F (11, 54)

Intermediate Songs troublesome spots = []

Four, Eb (7, 65, 67) [F#- B7]
Perdido, Bb (12, 65, 67) [bridge]
All Blues, G (5 0, 8 1) [D7+9, Eb7+9, D7+9]
Groovin High, Eb (43) [A- D7]
Yardbird Suite, C (6, 69) [bridge]
Softly As In A Morning Sunrise, C- (40) [bridge]
On Green Dolphin Street, Eb (34, 59)
Misty, Eb (41, 49, 70) [A- D7/ C- F7 in bridge]
Just Friends, F (20, 34, 59) [Ao or Ab-]
Killer Joe, C (14, 70) [bridge]
Sweet Georgia Brown (39, 67, 70, 84)
Indiana (Back Home Again In) (6, 61, 80, 84)
Girl From Ipanema, F (31, 70, 90)

Advanced Songs

Stella by Starlight, Bb or G (15, 22, 59, 68) [entire tune]
Star Eyes, Eb (34, 59) [bars 4, 5, & 6]
Invitation, C- (34, 59) [entire tune]
Have You Met Miss Jones?, F (25, 74) [bridge]
I Got Rhythm, Bb & F (7, 8, 16, 47, 51)
Giant Steps, Eb (28, 68) [entire tune]
All The Things You Are, Ab (16, 36, 43, 55) [entire tune]
Most ballads
Wayne Shorter tunes (33), Horace Silver tunes (17, 18), John Coltrane tunes (27, 28), Benny Golson tunes (14) and thousands of other songs

Memorize the melody

Memorize the chord progression

Memorize the various scales/chords

Be discriminate in your listening. Remember, you're training your MIND!
Choose your music like you would your friends.

Think of how many friends' voices you can recognize over the telephone after they say only one word. The qualities of scales (major, minor, dom.7th, dim.,etc.) will become just as familiar and easy to recognize with practice.

SCALES

Major	=	Δ	=	1	2	3	4	5	6	7	8
Dom. 7th	=	7	=	1	2	3	4	5	6	$\flat 7$	8
Minor (Dorian)	=	-	=	1	2	$\flat 3$	4	5	6	$\flat 7$	8

These are the three most-used scales and chords.

Half-dim.	=	\emptyset	=	1	$\flat 2$	$\flat 3$	4	$\flat 5$	$\flat 6$	$\flat 7$	8
		$B\emptyset = C^\Delta$	=	B	C	D	E	F	G	A	B

Half-diminished scales are the same as a major scale 1/2 step above.

#2 = "Half-dim.#2", like:	$B\emptyset\#2$	=	B	C^\sharp	D	E	F	G	A	B
---------------------------	-----------------------------------	----------	----------	------------------------------	----------	----------	----------	----------	----------	----------

Blues scale	=	1	$\flat 3$	4	<u>$\sharp 4$</u>	5	$\flat 7$	8
--------------------	----------	----------	-----------------------------	----------	-------------------------------------	----------	-----------------------------	----------

Major pentatonic	=	1	2	3	5	6	8
Minor pentatonic	=	1	$\flat 3$	4	5	$\flat 7$	8
Minor pent. (J. Coltrane)	=	1	2	$\flat 3$	5	6	8

**Scales are your best friends—get to know them inside out.
They'll do whatever you ask them to do. Make sure you know them well.**

<p>CHORDS Major = 1 3 5 <small>(Triads: 1, 3 & 5)</small> Minor = 1 $\flat 3$ 5 Diminished = 1 $\flat 3$ $\flat 5$ Augmented = 1 3 $\sharp 5$</p> <p>7th CHORDS Major = 1 3 5 7 = C^Δ <small>(1, 3, 5 & 7)</small> Dominant = 1 3 5 $\flat 7$ = $C7$ Minor = 1 $\flat 3$ 5 $\flat 7$ = $C-$ Diminished = 1 $\flat 3$ $\flat 5$ $\flat \flat 7$ (6th) = C° Dom. 7th $\sharp 5$ = 1 3 $\sharp 5$ $\flat 7$ = $C7+5$ Minor/Major 7th = 1 $\flat 3$ 5 7 = $C-\Delta$ Half-diminished = 1 $\flat 3$ $\flat 5$ $\flat 7$ = $C\emptyset$</p>	<ol style="list-style-type: none"> 1) Δ = Major 7th, it can mean a major scale (C^Δ) or it can mean a major 7th note ($C-\Delta$) 2) 7 = Lowered 7th 3) - = Minor (usually Dorian Minor) 4) \circ = Diminished scale or chord 5) \emptyset = Half-diminished scale or chord 6) + or \sharp = Raise the note 1/2 step 7) - or \flat = Lower the note 1/2 step 8) -3 = Minor third interval (=3 half-steps) 9) $\flat 9$ after a letter (dom.7th chord) means there are <u>3</u> altered tones: $\flat 9$, $\sharp 9$ & $\sharp 4$ 10) $\sharp 9$ after a letter (dom.7th chord) means there are <u>4</u> altered tones: $\flat 9$, $\sharp 9$, $\sharp 4$ & $\sharp 5$
--------------------------------------------------------------------------------------------------------------------------------------------------------------------------------------------------------------------------------------------------------------------------------------------------------------------------------------------------------------------------------------------------------------------------------------------------------------------------------------------------------------------------------------------------------------------------------------------------------------------------------------------------------------------------------------------------------------------------------------------------------------------------------------------------------------------------------------------------------------------------------------------------------------------------------------------------------	-------------------------------------------------------------------------------------------------------------------------------------------------------------------------------------------------------------------------------------------------------------------------------------------------------------------------------------------------------------------------------------------------------------------------------------------------------------------------------------------------------------------------------------------------------------------------------------------------------------------------------------------------------------------------------------------------------------------------------------------------------------------------------------------------------------------------------------------------------------------------------------------------------------------------------------------------------------------------------------

INTRODUCTION to the SCALE SYLLABUS

Each chord/scale symbol (C7, C-, CΔ+4, etc.) represents a series of tones which the improviser can use when improvising or soloing. These series of tones have traditionally been called scales. The scales listed here are the ones I most often hear musicians play. I have listed the Scale Syllabus in the key of C Concert so you can have a frame of reference and can compare the similarities and differences between the various chords/scales.

This SCALE SYLLABUS is intended to give the improviser a variety of scale choices which may be used over any chord—major, minor, dominant 7th, half-diminished, diminished and sus 4. Western music, especially jazz and pop, uses major, dominant 7th, dorian minor and Blues scales and chords more than any other. Scales and chords used less often are the half-diminished, diminished and sus 4. If we agree on these five chord/scale families as being the most predominant, then we can set them up as categories and list substitute scales beneath each heading...see the ***Scale Syllabus*** page. You should also check out **Volume 26 "The Scale Syllabus"** for more help with scales.

Each category begins with the scale most closely resembling the chord/scale symbol given to the left. The scales are arranged according to the degree of dissonance they produce in relation to the basic chord/scale sound. Scales near the top of each category will sound mild or consonant and scale choices further down the list will become increasingly tense or dissonant. Each player is urged to start with the scales at the top and with practice and experimentation gradually work his way down the list to the more dissonant or tension-producing scales. You should work with a new scale sound on your instrument until your ears and fingers become comfortable with all the tones in the scale. Also try singing the scale with your voice. Improvise with your voice over the scale you are learning and then play on your instrument what your voice sang.

Music is made of tension and release. Scale tones produce tension or they produce relaxation. The improviser's ability to control the amount and frequency of tension and release will in large measure determine whether he is successful in communicating to the listener. Remember—you, the player, are also a listener! Read pages 43 to 45 in **Volume 1 "JAZZ: How To Play And Improvise" (Sixth Edition)** for a more detailed explanation of tension and release in melodic development.

Any of the various practice procedures and patterns listed in **Volumes 1, 2, 3, 21, 24** or **84** can be applied to the learning and assimilation of any of the scale choices listed in this Scale Syllabus. Needless to say, any Scale you want to learn should be transposed and practiced in all twelve keys. The column on whole and half step construction I listed for each scale on the syllabus should prove helpful when transposing a scale to any of the twelve keys.

For additional information on scale substitution, I recommend "***Scales for Jazz Improvisation***" by Dan Haerle, "***Jazz Improvisation***" by David Baker, "***Patterns for Jazz***" and "***Complete Method for Jazz Improvisation***" by Jerry Coker, and "***Repository of Scales & Melodic Patterns***" by Yusef Lateef. These books are available from **Jamey Aebersold Jazz, Inc., PO Box 1244, New Albany, IN 47151-1244 U.S.A.**, your local music store, or **<http://www.jazzbooks.com>**.

Several play-a-long sets offer you an opportunity to practice the various scales in all twelve keys. They are: **Vol. 24 "Major & Minor"**; **Vol. 84 "Dominant 7th Workout"**; **Vol. 21 "Gettin' It Together"**; and **Vol. 16 "Turnarounds, Cycles & II/V7's."** You might also check out the play-a-longs which have tunes in all keys: **Vol. 42 "Blues In All Keys"**; **Vol. 47 "Rhythm In All Keys"**; **Vol. 57 "Minor Blues In All Keys"**; and two more volumes, **Vol. 67 "Tune Up"** and **Vol. 68 "Giant Steps"**—each has several classic tunes in all twelve keys.

Scales and chords are the backbone of our music and the better you equip yourself, the more fun you will have playing music.

SCALE SYLLABUS

LEGEND: H = Half Step, W = Whole Step.; Δ = Major 7th; + or # = raise H; b or - = lower H; ∅ = Half-diminished; -3 = 3H (Minor Third)

<u>CHORD/SCALE SYMBOL</u>	<u>SCALE NAME</u>	<u>WHOLE & HALF STEP CONSTRUCTION</u>	<u>SCALE IN KEY OF C</u>	<u>BASIC CHORD IN KEY OF C</u>
C	Major	W W H W W W H	C D E F G A B C	C E G B D
C7	Dominant 7th (Mixolydian)	W W H W W H W	C D E F G A B _b C	C E G B _b D
C-	Minor (Dorian)	W H W W W H W	C D E _b F G A B _b C	C E _b G B _b D
C∅	Half Diminished (Locrian)	H W W H W W W	C D _b E _b F G _b A _b B _b C	C E _b G _b B _b
C°	Diminished (8 tone scale)	W H W H W H W H	C D E _b F G _b A _b B C	C E _b G _b A (B _b)
1. MAJOR SCALE CHOICES				
CΔ (Can be written C)	Major (don't emphasize the 4th)	W W H W W W H	C D E F G A B C	C E G B D
C	Major Pentatonic	W W -3 W -3	C D E G A C	C E G B
CΔ+4	Lydian (major scale with +4)	W W W H W W H	C D E F _# G A B C	C E G B D
CΔ	Bebop (Major)	W W H W H W H	C D E F G _# A B C	C E G B D
CΔb6	Harmonic Major	W W H W H -3 H	C D E F G A _b B C	C E G B D
CΔ+5, +4	Lydian Augmented	W W W W H W H	C D E F _# G _# A B C	C E G _# B D
C	Augmented	-3 H -3 H -3 H	C D _# E G A _b B C	C E G B D
C	6th Mode of Harmonic Minor	-3 H W H W W H	C D _# E F _# G A B C	C E G B D
C	Diminished (begin with H step)	H W H W H W H W	C D _b D _# E F _# G A B _b C	C E G B D
C	Blues Scale	-3 W H H -3 W	C E _b F F _# G B _b C	C E G B D
2. DOMINANT 7th SCALE CHOICES				
C7	Dominant 7th	W W H W W H W	C D E F G A B _b C	C E G B _b D
C7	Major Pentatonic	W W -3 W -3	C D E G A C	C E G B _b D
C7	Bebop (Dominant)	W W H W W H H H	C D E F G A B _b B C	C E G B _b D
C7b9	Spanish or Jewish scale	H -3 H W H W W	C D _b E F G A _b B _b C	C E G B _b (D _b)
C7+4	Lydian Dominant	W W W H W H W	C D E F _# G A B _b C	C E G B _b D
C7b6	Hindu	W W H W H W W	C D E F G A _b B _b C	C E G B _b D
C7+ (has #4 & #5)	Whole Tone (6 tone scale)	W W W W W W	C D E F _# G _# B _b C	C E G _# B _b D
C7b9 (also has #9 & #4)	Diminished (begin with H step)	H W H W H W H W	C D _b D _# E F _# G A B _b C	C E G B _b D _b (D _#)
C7+9 (also has b9, #4, #5)	Diminished Whole Tone	H W H W W W W	C D _b D _# E F _# G _# B _b C	C E G _# B _b D _# (D _b)
C7	Blues Scale	-3 W H H -3 W	C E _b F F _# G B _b C	C E G B _b D (D _#)
C7 sus 4	Dom. 7th scale but don't emphasize the third	W W H W W H W	C D E F G A B _b C	C F G B _b D
C7 sus 4	Major Pentatonic built on b7	W W -3 W -3	B _b C D F G B _b	C F G B _b D
C7 sus 4	Bebop Scale	W W H W W H H H	C D E F G A B _b B C	C F G B _b D
3. MINOR SCALE CHOICES*				
C- or C-7	Minor (Dorian)	W H W W W H W	C D E _b F G A B _b C	C E _b G B _b D
C- or C-7	Pentatonic (Minor Pentatonic)	-3 W W -3 W	C E _b F G B _b C	C E _b G B _b D
C- or C-7	Bebop (Minor)	W H H H W W H W	C D E _b E F G A B _b C	C E _b G B _b D
C-Δ (maj. 7th)	Melodic Minor (ascending)	W H W W W W H	C D E _b F G A B C	C E _b G B D
C- or C-6 or C-	Bebop Minor No. 2	W H W H H W H W	C D E _b F G G _# A B C	C E _b G B D
C- or C-7	Blues Scale	-3 W H H -3 W	C E _b F F _# G B _b C	C E _b G B _b D
C-Δ (b6 & maj. 7th)	Harmonic Minor	W H W W H -3 H	C D E _b F G A _b B C	C E _b G B D
C- or C-7	Diminished (begin with W step)	W H W H W H W H	C D E _b F F _# G _# A B C	C E _b G B D
C- or C-b9b6	Phrygian	H W W W H W W	C D _b E _b F G A _b B _b C	C E _b G B _b
C- or C-b6	Pure or Natural Minor, Aeolian	W H W W H W W	C D E _b F G A _b B _b C	C E _b G B _b D
4. HALF DIMINISHED SCALE CHOICES				
C∅	Half Diminished (Locrian)	H W W H W W W	C D _b E _b F G _b A _b B _b C	C E _b G _b B _b
C∅#2 (C∅9)	Half Diminished #2 (Locrian #2)	W H W H W W W	C D E _b F G _b A _b B _b C	C E _b G _b B _b D
C∅ (with or without #2)	Bebop Scale	H W W H H H W W	C D _b E _b F G _b G A _b B _b C	C E _b G _b B _b
5. DIMINISHED SCALE CHOICES				
C°	Diminished (8 tone scale)	W H W H W H W H	C D E _b F G _b A _b B C	C E _b G _b A

NOTES: 1) The above chord symbol guide is my system of notation. I feel it best represents the sounds I hear in jazz. The player should be aware that each chord symbol represents a series of tones called a scale. 2) Even though a C7+9 would appear to have only a raised 9th, it also has a b9, +4 and +5. So the entire C7+9 scale would look like: Root, b9, +9, 3rd, +4, +5, b7 & root (C, D_b, D_#, E, F_#, G_#, B_b, C). My chord symbol C7+9 is therefore an abbreviation, while the complete name of this scale is Diminished Whole Tone (sometimes called Super Locrian or Altered Scale). Similarly, C7b9 also appears to have only one altered tone (b9) but it actually has three: b9, +9 and +4. The entire scale looks like this: Root, b9, +9, 3rd, +4, 5th, 6th, b7 & root (C, D_b, D_#, E, F_#, G, A, B_b, C). This is called a Diminished scale and my chord symbol abbreviation is C7b9. 3) All scales under the Dominant 7th category are scales that embellish the basic Dominant 7th sound. Some scales provide much more tension than the basic dominant 7th sound and require practice and patience to grasp the essence of their meaning. I encourage you to work with the first side of Volume 3 "The 11-V7-1 Progression" since it emphasizes Diminished and Diminished Whole Tone scales and chords. 4) * - In category #3, MINOR SCALE CHOICES, the PURE MINOR scale choice is not used very often. I have found the order of preference to be Dorian, Bebop, Melodic, Blues, Pentatonic, and then any of the remaining Minor scale choices.

NOMENCLATURE

+ or # = raise 1/2 step - or b = lower 1/2 step H = Half step W = Whole step

Because jazz players, composers, educators and authors haven't agreed on a common nomenclature for writing chord and scale symbols, the novice will have to become familiar with several different ways of writing the same scale sound.

Listed below are the most common symbols in order of usage—most-used to least-used. The symbol that is boldface is the one I use most often. Notice that throughout this book you will see **CΔ** and **C** to designate a major chord/scale sound. I am doing this so you can begin to get better acquainted with various nomenclature.

Δ = major scale/chord or major seventh (CΔ). A (7) after a letter means to lower the 7th note of the scale, making it a Dominant 7th quality (C7). A dash (-) when located beside a letter means to lower the third and seventh of the scale 1/2 step, thus making it a minor tonality (Dorian minor) (C-). ∅ means half-diminished (C∅). C-Δ means a minor scale/chord with a major 7th. -3 means 3 half-steps (a minor 3rd).

CHORD/SCALE TYPE	ABBREVIATED CHORD/SCALE SYMBOL
* MAJOR (Ionian) (WWHWWWH) C D E F G A B C	C Δ Cmaj, Cma, Cma7, Cmaj7, CM, CM7, Cmaj9, Cmaj13
* DOMINANT SEVENTH (Mixolydian) (WWHWWHW) 5th mode of Major C D E F G A Bb C	C7 C9, C11, C13
* MINOR SEVENTH (Dorian) (WHWWWHW) 2nd mode of Major C D Eb F G A Bb C	C- C-7 Cmi, Cmi7, Cm7, Cmin, Cmin7, Cm9, Cm11, Cm13
LYDIAN (Major scale with #4) (WWWHWWH) 4th mode of Major C D E F# G A B C	CΔ+4 Cmaj+4, CM+4, CΔ+11, CΔb5, Cmajb5
* HALF-DIMINISHED (Locrian) (HWWHWWWW) 7th mode of Major C Db Eb F Gb Ab Bb C	C∅ Cmi7(b5), C-7b5
HALF-DIMINISHED #2 (Locrian #2) (WHWHWWWW) 6th mode of Melodic Minor C D Eb F Gb Ab Bb C	C∅#2 C∅+2, C∅9
DIMINISHED (WHWHWHWH) C D Eb F Gb Ab A B C	C° Cdim, C°7, Cdim7, C°9
LYDIAN DOMINANT (Dom. 7th with #4) (WWWHWHW) 4th mode of Melodic Minor C D E F# G A Bb C	C7+4 C7+11, C7b5, C9+11, C13+11
WHOLE-TONE (WWWWWWW) C D E F# G# Bb C	C7+ C7aug, C7+5, C7+5
DOMINANT SEVENTH <u>Using a Dim. Scale</u> (HWHWHWHW) C Db D# E F# G A Bb C	C7b9 C7b9+4, C13b9+11
DIMINISHED WHOLE-TONE (Altered scale) (HWHWWWWW) 7th mode of Melodic Minor C Db D# E F# G# Bb G	C7+9 C7alt, C7b9+4, C7b9+11
LYDIAN AUGMENTED (Major with #4 & #5) (WWWHWHW) 3rd mode of Melodic minor C D E F# G# A B C	CΔ+5 CΔ+5
MELODIC MINOR (ascending only) (WHWWWWWH) C D Eb F G A B C	C-Δ Cmin(maj7), CmiΔ, C-Δ (Melodic), Cm6
HARMONIC MINOR (WHWWH-3H) C D Eb F G Ab B C	C-Δ CmiΔ, C-Δ (Har), C-Δb6
SUSPENDED 4th (W-3WWHW) or (WWHWWHW) C D F G A Bb C C D E F G A Bb C	G- G- G-7, C7sus4, C7sus, C4, C11 C C
* BLUES SCALE (use at player's discretion) (-3WHH-3W) (1, b3, 4, #4, 5, b7, 1) C Eb F F# G Bb C	(There is no chord symbol for the Blues scale) Used mostly with dominant and minor chords

* These are the most common chord/scales in Western music.

I believe in a reduced chord/scale notation that allows our creative side, our natural side (right brain function) to have direction and guidance without feeling inhibited or limited.

When we speak of "quality" we mean whether it is Major, Minor, Dim., or whatever.

I have tried to standardize the chord/scale symbol notation in my books. Since some have been out many years there are instances where I may have used a different chord symbol in one book than I used in this one.

I feel the improviser needs as little notation as possible in order to transcend the actual nomenclature on the page. The more numbers, letters and alterations that appear on the page, the less chance they will have to remove their thoughts from the written page and express what is being heard in their mind. That is why I prefer **C**, **C7**, **C-**, **C∅**, **C7+9**, **C7b9**. Remember, we are playing a music called jazz, and it contains many altered tones. Once we learn the various alterations and their corresponding abbreviated chord symbol, why keep writing all the alterations beside the chord symbol? Check out carefully the Scale Syllabus! Listen to Volume 26 "The Scale Syllabus."

Remember. 2nd's are the same as 9th's, 4th's are the same as 11th's, 13th's are the same as 6th's. Example: Key of C ... the 2nd, D, is the same as the 9th, D. Often a composer will simply write their preferred name of the scale beside the chord symbol, such as Eb-Δ (melodic minor), F- (phrygian), F-(phry).

TIPS FOR LEARNING A NEW TUNE

1. Listen to the song over and over.
2. Memorize the melody in your mind. Be able to sing it.
3. Listen carefully to the bass line and the harmony in general. Get an overall sense of how the song is put together.
4. Try playing the melody from memory, slowly at first.
5. Then play the melody along with the recording. Copy inflections, articulations, slurs, phrasing, dynamics, etc.
6. Learn the scales and chords in the order as they appear in the song. Make sure you've got the right changes (chord progression). Get them from a reliable source, such as the play-along books.
7. Improvise over the harmony, keeping in mind the original melody as a frame of reference.
8. Emphasize the thirds and sevenths of scales in your soloing.
9. Memorize both melody and chord/scales if you haven't already. Know where the chord tones are ON YOUR INSTRUMENT.
10. Improvise your original melodies based on what your mind HEARS. Let your mind guide your choice of notes, phrasing, rhythms, articulations, etc...
11. Listen constantly to the original recording of the song to further stir your imagination. Incorporate ideas of the recording into your solos.
12. Learn the lyrics if the song has any. Mentally sing the lyrics while playing the melody.
13. Fall in love with the melodies to songs. Play them like YOU wrote them.

"I've always tried to recreate melodies even better than the composers who wrote them. I've always tried to come up with something that never even occurred to them. This is the challenge: not to rearrange the intentions of the composers but to stay within the parameters or what the composers have in mind and be creative and imaginative and meaningful." -- **tenor saxophonist Joe Henderson**

(Taken from Jamey's volume 1 book: "How to Play and Improvise")

PRACTICE PROCEDURES FOR MEMORIZING SCALES AND CHORDS TO ANY SONG

1. Play root/tonic note of each chord/scale
2. Play first 2 notes of each scale
3. Play first 3 notes of each scale
4. Play the first five notes of each scale
5. Play triad of the scale (1, 3, and 5 of the scale)
6. Play 7th chords (1, 3, 5, and 7th tones of the scale)
7. Play 9th chords (1, 3, 5, 7, and 9th tones of the scale)
8. Play the entire scale up and down
9. Play 6th chords (1, 3, 5, and 6th tones of the scale)
10. Play up the scale to the 9th and back down the chord tones
11. Play up the 9th chord and then come back down the scale
12. Play the scale in broken thirds up and down (1, 3, 2, 4, 3, 5, 4, 6, 5, 7, etc., up & down)

The above approach can be used when learning the scales and chords to ANY song, or, when learning any new scale. You may want to use a metronome when the tempo on the recording is too fast for you. You'll want to play these exercises UP and DOWN. If you feel you need further practice with any particular scale/chord there are many more patterns and exercises available from various practice books.

Once you become familiar with the various scales and chords and gain adequate facility you won't have to practice these type exercises any more. Remember, the exercises are merely to help you MAKE MUSIC.

BASIC KEYBOARD and CHROMATIC SCALE

- Notes **ascend** as they go to the keyboard's right. Up the keyboard.
- Notes **descend** as they go to the keyboard's left. Down the keyboard.
- An **interval** is the distance between any two notes.
- Half-steps** and **whole-steps** are the units which are used to measure intervals.
- The interval between any two successive notes on the keyboard is a **half-step**. Two half-steps equal one **whole-step**.
- A -3 is called a **minor third** and equals 3 half-steps. A M3 is called a **major third** (4 half-steps).
- # or + means to raise the note a half-step.
- b or - means to lower the note a half-step.
- H = Half-step; W = Whole-step.
- Intervals can be either **major**, **minor**, **augmented**, **diminished**, or **perfect**.

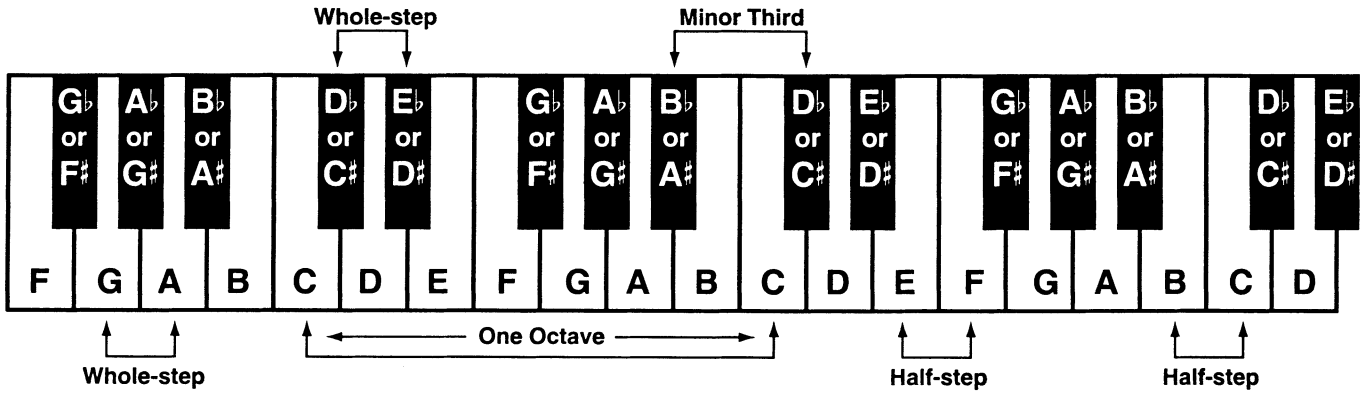

Examples of scale construction: C major scale = W, W, H, W, W, W, H.

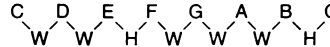

G7+9 (Diminished whole-tone) = H, W, H, W, W, W, W.

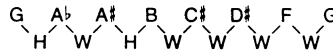

CHROMATIC SCALE

USING SHARPS

TREBLE CLEF

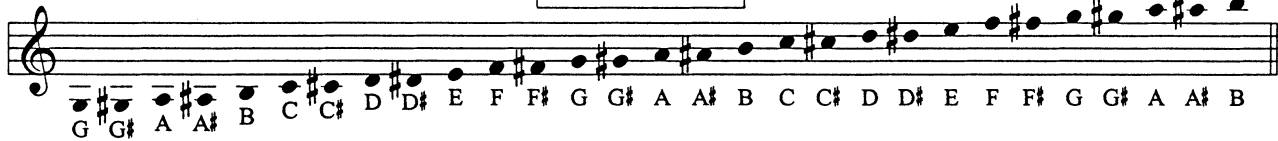

USING FLATS

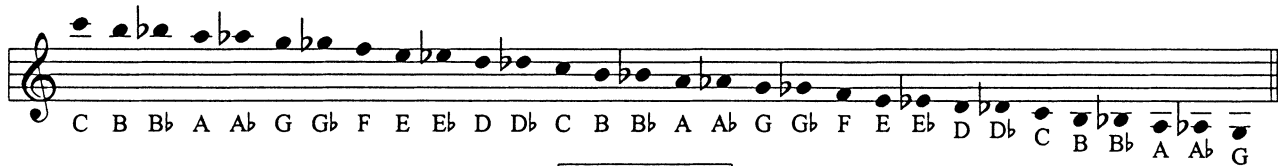

USING SHARPS

BASS CLEF



USING FLATS



PREPARATORY EXERCISES - BASS CLEF



Below are several exercises every musician should memorize and be able to play in all MAJOR, MINOR (Dorian minor), and DOMINANT 7th keys. These are basic exercises which will help you gain speed and dexterity. Begin by practicing slowly, then gradually increase speed. Strive for smoothness and slur each exercise. Keyboard and string players should play legato. After you get the feel of several, consult the ARTICULATIONS article. These exercises are great for warming up each day. You can apply these to ANY scale or chord, regardless of quality. Due to space considerations, I have only listed three qualities.

CHROMATIC SCALE ONE OCTAVE

1 Major

2 Dominant 7th

3 Minor

4 Major

5 Dominant 7th

6 Minor

7 Major

8 Dominant 7th

9 Minor

10 Major

PLAY 3 TIMES

PLAY 4 TIMES

PLAY 4 TIMES

EXERCISES ON BLUES SCALE

I strongly urge you to practice the above exercises, using as a guide any of the following root sequences to assure yourself of practice in all keys.

1. C Db D Eb E F F# G Ab A Bb B C
2. C F Bb Eb Ab Db Gb B E A D G C
3. C D E F# Ab Bb/ Db Eb F G A B Db
4. C Eb Gb A/ Db E G Bb/ D F Ab B
5. C B Bb A Ab G Gb F E Eb D Db C
6. C Eb Db E D F Eb Gb E G F Ab Gb A G Bb Ab B A C

Jazz is creative. Creation involves change. How much are you willing to change?

TREBLE CLEF SCALES

Major, Dominant 7th, and Minor Scales

The scales are written in all 12 keys from the root (first note of any scale) to the 9th of that scale. The blackened-in notes are chord tones: root, 3rd, 5th, 7th and 9th

The 12 Major (Ionian) Scales To The 9th

Half & Whole Step Construction: WWHWWHW

The 12 Dominant 7th (Mixolydian) Scales To The 9th

Half & Whole Step Construction: WWHWWHW

The 12 Minor (Dorian) Scales To The 9th

Half & Whole Step Construction: WWHWWHW

Your voice has been with you much longer than your instrument.
Use it to sing with, then transfer the music to your instrument.

TREBLE CLEF SCALES

Whole Tone Scales (Augmented)

Half & Whole Step Construction: WWHWWHW

There are only two Whole Tone Scales

Chord symbols: C7, Eb7 (Cb7), B7, G7, A7, B7

Diminished Scales

Half & Whole Step Construction: WWHWWHW

There are only three Diminished Scales

This Diminished scale fits these chord symbols: C7, Eb7, Gb7, A7, Bb7 also D7b9, F7b9, Ab7b9, F7b9, C7b9

Dim. Whole Tone Scales

Half & Whole Step Construction: WWHWWHW

Also called "Altered" or "Super Locrian"

Contains b9, #9, #4, #5. In addition to the root, 3rd & b7th

Half-Diminished Scales

Half & Whole Step Construction: WWHWWHW

called (minor 7b5) or Locrian. Raise second tone a half-step to form the Half-Dim. 7 Scale

BASS CLEF SCALES

Major, Dominant 7th, and Minor Scales

The scales are written in all 12 keys from the root (first note of any scale) to the 9th of that scale. The blackened-in notes are chord tones: root, 3rd, 5th, 7th and 9th

The 12 Major (Ionian) Scales To The 9th

Half & Whole Step Construction: WWHWWWH

C Δ F Δ B Δ
 E Δ A Δ D Δ
 G Δ (G Δ) Δ B Δ E Δ
 A Δ D Δ G Δ

The 12 Dominant 7th (Mixolydian) Scales To The 9th

Half & Whole Step Construction: WWHWWH

C⁷ F⁷ B⁷
 E⁷ A⁷ D⁷ (D⁷)
 G⁷ (G⁷)
 A⁷

The 12 Minor (Dorian) Scales To The 9th

Half & Whole Step Construction: WHWWWH

C⁻ F⁻ B⁻
 E⁻ A⁻ D⁻ (D⁻)
 G⁻ (G⁻)
 A⁻

△

7

—

It doesn't hurt to think, to use your mind. Of course your ego will tell you otherwise.

BASS CLEF SCALES

Whole Tone Scales (Augmented)

Half & Whole Step Construction: WWWW

There are only two Whole Tone Scales: C⁷, E⁷, A⁷ (C⁷, B⁷)

Diminished Scales

Half & Whole Step Construction: WHWHWHWH

There are only three Diminished Scales

This Diminished scale fits these chord symbols: C⁷, E⁷, G⁷, A⁷ also D⁷b9, F⁷b9, A⁷b9, C⁷b9

Dim. Whole Tone Scales

Half & Whole Step Construction: HWHW

Also called "Altered" or "Super Locrian". Contains b9, #9, #4, #5, in addition to the root, 3rd & 6th

C[#]
 D^{b9} (C^{#m})
 D^m
 E^{b9} (D^{#m})
 E^m
 F^m
 F^{b9} (E^{#m})
 G^m
 A^{b9} (G^{#m})
 A^m
 B^{b9} (A^{#m})
 B^m

Half-Diminished Scales

Half & Whole Step Construction: HWHW

called (minor 7, b5) or "Locrian". Raise second tone a half-step to form the Half-Dim. #2 Scale

C⁷
 C⁷ (D^{b9})
 D⁷
 E⁷ (F^{b9})
 F⁷
 F⁷ (G^{b9})
 G⁷
 A⁷ (B^{b9})
 A⁷
 B⁷ (A^{b9})
 B⁷



+

○

∅

EAR TRAINING

When a person tries to develop his capacity to better hear the sounds going on around him, he is faced with several problems which aren't necessarily present when reading music or chord symbols from the written page.

Having "good ears" means having the ability to hear the roots to the various chords or scales that are being played; having the ability to hear the quality of the chord or scale ... major, minor (what kind of minor?), pentatonic, dim. whole tone, etc.; it means having the ability to tell what tone of the scale or chord is being played at any point in the solo ... "ah, that note was the #4 resolving to the 6th resolving to the 5th!"; it means hearing the piano, bass, soloist, drums, etc. individually as well as collectively.

I have found that there are many levels of hearing. Some people hear. Some people can really hear! And some people can seem to hear and identify almost anything that is being played. They can seem to sing or play back portions of solos right after the performer has played. How can they HEAR, and we can't seem to find the roots, scale, qualities, or what time signature the piece is in?

I'm firmly convinced that if all students from the first grade (even kindergarten) through their last year in college were exposed to simple ear training exercises that allowed them the opportunity to identify what they were hearing on the radio, TV, records, jazz, opera, orchestra, chorus, band, etc., our music scene in general would be much different! In my opinion, if simple ear training exercises, coupled with simple music theory, were carried out in public school, the public would demand music of a much higher calibre than they are presently consuming. Why would they demand "better" music? Because they would HEAR that the music they are being fed is too repetitious, trite, and banal to warrant our attention, much less our money on the sales of records or concert attendance.

One of the reasons jazz music, especially the music from Bebop to the present, has never had a big audience is due to the amount of thinking required to actually get to the essence of the music. The average person today doesn't want to think about music, he just wants to enjoy it. And he usually will settle for the same thing day after day. He feels life is too difficult to have to think about the music he is listening to. Hence the gap between the performer and the listener in the world today. I do not mean to imply that listening to music intellectually is not enjoyable.

This would be an excellent time to read Jerry Coker's *Listening to Jazz*, published by Prentice-Hall. This is a great book on how to listen to jazz and is accessible to the layman.

For ear training purposes, Volume 21 "Gettin' It Together" (2 CDs/Bk) of the Aebersold Play-along series will give you much to work with:

I suggest beginning by simply putting the first track on and sing the roots. After singing the roots, sing the first five notes of the scale. Then, try singing the triad, 1, 3, and 5 of the scales. By this time you can probably sing the entire scale. Don't forget to sing the 7th chord and the 9th chord, just like you are doing with your instrument. Also, don't forget to isolate individual pitches and sing them, such as the 5th or the 9th or the 3rd, etc.

Try starting in the middle of any of the tracks (begin with major) and see how long it takes you to find the root. You may want to sit at the piano while doing this in order to occasionally check yourself. After you find the root, can you sing the scale or even improvise?

All the time you are singing, be aware that each tone in the scale or chord has a number assigned to it. Be thinking these various numbers whenever possible.

Put the CDs on cassettes if you need to so you can play them in your car. Sing exercises, patterns, and improvise. While doing so, be aware of the pitch you are singing. You may want to buy a pitch pipe and keep it in your car to help identify the roots, 3rd's, 5th's, etc.

Being able to sing and identify intervals is a key part of ear training.

Experiment with singing or playing with the left channel of the recording only. Listen carefully to the bass.

I have found it helpful to memorize a song title that begins with a certain interval. For instance, the interval of a perfect 4th is the first two notes of *Here Comes the Bride*. By singing the first two notes of *Here Comes the Bride* and realizing it outlines a perfect 4th interval you can begin to center in on perfect 4th's whenever they are sounded. Or, it may help you to actually sing, or play on your instrument, in tune, the interval of a perfect 4th.

I like to use an Interval Chart as a guide to identify correctly whatever interval is being played. I made my chart by listing intervals and some songs that begin with that particular interval. Remember, intervals ascend and descend.

INTERVAL CHART

I have found it helpful to memorize a song title that begins with a certain interval. For instance, the interval of a perfect 4th is the first two notes of *Here Comes the Bride*. By singing the first two notes of *Here Comes the Bride* and realizing it outlines a perfect 4th interval you can begin to center in on perfect 4th's whenever they are sounded. Or, it may help you to actually sing, or play on your instrument, in tune, the interval of a perfect 4th.

Each of these songs begins with the interval listed TO THE LEFT.

I like to use the following table as a guide to identify correctly whatever interval is being played:

	Ascending Intervals	Descending Intervals
-2	NICE WORK IF YOU CAN GET IT BYE BYE BLACKBIRD SAN FRANCISCO (LEFT MY HEART) WHAT'S NEW I REMEMBER YOU JAWS I'M GETTING SENTIMENTAL OVER YOU	MAJOR SCALE (DESCENDING) SOPHISTICATED LADY O LITTLE TOWN OF BETHLEHEM STELLA BY STARLIGHT JOY TO THE WORLD THE LADY IS A TRAMP THE THEME (M.DAVIS) SOLAR (M.DAVIS)
M2	MAJOR SCALE (ASCENDING) HAPPY BIRTHDAY RUDOLF, RED NOSE. . . MY FUNNY VALENTINE SILENT NIGHT BODY AND SOUL THERE WILL NEVER BE ANOTHER YOU TENNESSEE WALTZ	MARY HAD A LITTLE LAMB M.A.S.H. DECK THE HALLS BLUE MOON AWAY IN A MANGER SATIN DOLL YESTERDAY (BEATLES) TUNE UP ON THE SUNNY SIDE OF THE STREET MY GIRL FREDDIE FREELoader THE FIRST NOEL
-3	WORK SONG GEORGIA ON MY MIND MINOR CHORD MOONTRANE CONFIRMATION THE IMPOSSIBLE DREAM A FOGGY DAY SOMEWHERE MY LOVE	FROSTY THE SNOWMAN HEY JUDE WHAT IS THIS THING CALLED LOVE PETER GUNN 500 MILES HIGH (C.COREA) MISTY
M3	MAJOR TRIAD OH WHEN THE SAINTS I CAN'T GET STARTED	SUMMERTIME GIANT STEPS COME RAIN OR COME SHINE BESSIE'S BLUES
P4	HERE COMES THE BRIDE ALL THE THINGS HARK THE HERALD ANGELS ORNITHOLOGY OH CHRISTMAS TREE SONG FOR MY FATHER DOXY LOVE ME TENDER 'ROUND MIDNIGHT AULD LANG SYNE MAIDEN VOYAGE WE WISH YOU A MERRY CHRISTMAS	OH COME, ALL YE FAITHFUL VALSE HOT (NOT INTRO!) YARDBIRD SUITE SOFTLY, AS IN A MORNING SUNRISE I DIDN'T KNOW WHAT TIME IT WAS
#4 or b5	MARIA (WEST SIDE STORY)	BLUE SEVEN (SONNY ROLLINS)
P5	TWINKLE TWINKLE LITTLE STAR BAGS GROOVE THEME from 2001 WHISPER NOT (BENNY GOLSON)	FEELINGS 7 STEPS TO HEAVEN (M.DAVIS) HAVE YOU MET MISS JONES?
#5 or b6	MORNING OF THE CARNIVAL	3rd tone of MISTY (1ST TO 3RD TONE) LOVE STORY YOU'RE EVERYTHING (C.COREA) PLEASE DON'T TALK ABOUT ME WHEN I'M GONE
M6	IT CAME UPON A MIDNIGHT CLEAR NBC DAYS OF WINE AND ROSES INCH WORM TAKE THE "A" TRAIN SPEAKLOW	YOU'RE A WEAVER OF DREAMS
b7	SOMEWHERE (WEST SIDE STORY) THEME from STAR TREK I'LL CLOSE MY EYES	WATERMELON MAN (H.HANCOCK) LITTLE RED'S FANTASY (WOODY SHAW) 3rd tone of HONEYSUCKLE ROSE (1ST AND 3RD NOTE)
M7	CAST YOUR FATE TO THE WIND CEORA THEME from FANTASY ISLAND	I LOVE YOU
8va (octave)	A CHRISTMAS SONG (CHESTNUTS. . .) DEL SASSER LET IT SNOW BLUEBOSSA SOMEWHERE OVER THE RAINBOW McDONALD'S COMMERCIAL	I LOVE YOU (THE OTHER ONE!) WILLOW WEEP FOR ME

I am listing intervals that correspond with standards or kiddie tunes of the past 40 years. If you are not familiar with these songs, they probably won't help you in identifying intervals. In that case, I suggest you write down song titles that you are familiar with, such as current commercials on TV or radio, pop songs, religious songs, or anything that begins with an interval you need to work on. It is usually harder to find songs that begin with descending intervals.

PREPARATORY EXERCISES - TREBLE CLEF



Below are several exercises every musician should memorize and be able to play in all MAJOR, MINOR (Dorian minor), and DOMINANT 7th keys. These are basic exercises which will help you gain speed and dexterity. Begin by practicing slowly, then gradually increase speed. Strive for smoothness and slur each exercise. Keyboard and string players should play legato. After you get the feel of several, consult the ARTICULATIONS article. These exercises are great for warming up each day. You can apply these to ANY scale or chord, regardless of quality. Due to space considerations, I have only listed three qualities.

CHROMATIC SCALE ONE OCTAVE

1. **Major** (Learn the CHROMATIC SCALE from your lowest note to the highest)

2. **Dominant 7th** (C7)

3. **Minor (DORIAN)** (C-)

4. **Major** (C Δ FIRST 5 NOTES)

5. **Major** (C Δ FULL SCALE TO THE 9TH)

6. **Major** (C Δ ROOT, 3RD, 5TH (TRIAD))

7. **Major** (C Δ 7TH CHORD (ROOT, 3RD, 5TH, 7TH))

8. **Major** (C Δ 9TH CHORD (ROOT, 3RD, 5TH, 7TH, 9TH))

9. **Major** (C Δ 9TH CHORD ASCENDING & FULL SCALE DESCENDING (PLAY 4 TIMES))

10. **Major** (C Δ FULL SCALE ASCENDING & NINTH CHORD DESCENDING (PLAY 4 TIMES))

EXERCISES ON BLUES SCALE

1. **Major** (C Δ)

2. **Dominant 7th** (C7)

3. **Minor (DORIAN)** (C-)

4. **Major** (C Δ)

5. **Dominant 7th** (C7)

6. **Minor (DORIAN)** (C-)

7. **Major** (C Δ)

8. **Dominant 7th** (C7)

9. **Minor (DORIAN)** (C-)

10. **Major** (C Δ)

I strongly urge you to practice the above exercises, using as a guide any of the following root sequences to assure yourself of practice in all keys.

1. C Db D Eb E F F# G Ab A Bb B C
2. C F Bb Eb Ab Db Gb B E A D G C
3. C D E F# Ab Bb/ Db Eb F G A B Db
4. C Eb Gb A/ Db E G Bb/ D F Ab B
5. C B Bb A Ab G Gb F E Eb D Db C
6. C Eb Db E D F Eb Gb E G F Ab Gb A G Bb Ab B A C

Adults often have to fight their way back to intuition - George Bouchard

Blues Progressions

from Volume 21 "Gettin' It Together" of the Aebersold Play-a-long Series

Treble Clef C Instruments:

30

F BLUES (concert key)
8 choruses of 12 bar blues



F BLUES

Musical notation for F Blues progression, 8 choruses of 12 bar blues. The key signature is one flat (Bb). The progression consists of three systems of four staves each. The first system shows the melody with chords F7, Bb7, and F7. The second system shows the bass line with chords Bb7, F7, and Bb7. The third system shows the melody with chords C7, Bb7, and C7. The piece ends with a double bar line and a repeat sign.

F Blues Scale

Diagram of the F Blues scale in concert key (one flat), consisting of the notes F, G, Ab, Bb, C, and D.

F Blues scale may be played anytime during the F Blues

31

Bb BLUES (concert key)
10 choruses of 12 bar blues

Bb BLUES

Musical notation for Bb Blues progression, 10 choruses of 12 bar blues. The key signature is two flats (Bb and Eb). The progression consists of three systems of four staves each. The first system shows the melody with chords Bb7, Eb7, and Bb7. The second system shows the bass line with chords Bb7, Eb7, and Bb7. The third system shows the melody with chords C-, Bb7, and F7. The piece ends with a double bar line and a repeat sign.

Bb Blues Scale

Diagram of the Bb Blues scale in concert key (two flats), consisting of the notes Bb, C, Db, Eb, F, and G.

Bb Blues scale may be played anytime during the Bb Blues

Bb Instruments:

30

F BLUES (concert key)
8 choruses of 12 bar blues



G BLUES (F CONCERT BLUES)

Musical notation for G Blues progression (F concert blues), 8 choruses of 12 bar blues. The key signature is one flat (Bb). The progression consists of three systems of four staves each. The first system shows the melody with chords G7, C7, and G7. The second system shows the bass line with chords C7, G7, and C7. The third system shows the melody with chords D7, G7, and D7. The piece ends with a double bar line and a repeat sign.

G Blues scale

Diagram of the G Blues scale in concert key (one flat), consisting of the notes G, A, Bb, C, D, and E.

G Blues scale may be played at anytime during the G Blues

31

Bb BLUES (concert key)
10 choruses of 12 bar blues

C BLUES (Bb CONCERT BLUES)

Musical notation for C Blues progression (Bb concert blues), 10 choruses of 12 bar blues. The key signature is one flat (Bb). The progression consists of three systems of four staves each. The first system shows the melody with chords C7, C7, and C7. The second system shows the bass line with chords F7, C7, and A7. The third system shows the melody with chords D-, G7, and C7. The piece ends with a double bar line and a repeat sign.

C Blues scale

Diagram of the C Blues scale in concert key (one flat), consisting of the notes C, D, Eb, F, G, and Ab.

C Blues scale may be played anytime during the C Blues

HOW TO PRACTICE IMPROVISATION

by **JERRY COKER**

Given below is an example of a schedule that may help you to organize your practice time. This schedule is based on a seventy-five minute period (1 hr., 15 min.), but it could be changed proportionately to fit a shorter or longer period or modified to allow time to take up instrumental studies (long tones, dexterity exercises for the fingers, range studies, reading, etc.).

A DAILY PRACTICE SCHEDULE:

Topic Sequence	Minutes Spent
1) A SLOW MELODY (tune)	5
2) SCALES AND PATTERNS	15
3) PATTERN APPLICATION	10
4) IMPROVISATION EXERCISE	5
5) TRANSCRIBED SOLO	15
6) SPECIAL DISCIPLINES	10
7) LEARN A TUNE	<u>15</u>
	TOTAL 75

A new set of melodies, patterns, exercises, transcribed solos, disciplines, and tunes should be taken up each week. Such a turnover in materials will help insure a steady rate of progress. Items 3 through 7 should be played with recorded accompaniment. "SPECIAL DISCIPLINES" refers to studies aimed at resolving weakness in areas such as playing fast tempos, time-feeling, use of all rhythmic levels, building intensity, or cultivating a melodic sense. The learning of a tune should encompass melody, chord progression, appropriate ingredients, and familiarization with the most significant recordings of the tune (the listening is done at another time, however).

Be sure to check out these books by Jerry Coker:

IMPROVISING JAZZ, LISTENING TO JAZZ, PATTERNS FOR JAZZ, THE COMPLETE METHOD FOR IMPROVISATION, HOW TO PRACTICE JAZZ and *HOW TO TEACH JAZZ*. All of these books are available from Aebersold Jazz -- see our website at <http://www.jazzbooks.com>

HOW TO PRACTICE

by **DAVID LIEBMAN**

One major point to remember concerns the avoidance of attempting to accomplish too many goals while practicing. The mind cannot easily digest more than one or two major points at the same time and still be effective. Always be very clear as to what you are practicing a particular exercise for. Example: Long tones on saxophone are for breathing and evenness of sound—no inflections, vibrato, etc. Scales are for speed and fingering difficulties, etc.

Be sure to check out these materials by David Liebman:

Volume 19 "David Liebman," Volume 26 "The Scale Syllabus," and Volume 81 "Contemporary Standards and Originals with the David Liebman Group" --all of these are part of the Aebersold Play-A-Long Series. Also see the Aebersold Jazz catalog for the most up-to-date listing of additional materials available from David Liebman.

THINGS THAT CREATE INTEREST WHEN SOLOING

REPETITION

SEQUENCE

DYNAMICS - Loud & Soft

RANGE - TESSITURA - High, Low, Middle register

ACCENTS

HELD NOTES

REST - SILENCE

RHYTHMIC VARIATION

VARIETY - But not too much!

BLUES SCALE USAGE

TENSION & RELEASE

MOTIFS

KNOW WHERE CHORD TONES ARE: Tones 1, 3, 5, and 7

WIND PLAYERS - SUPPORT YOUR SOUND/TONE

CHORD OR SCALE PASSAGES

TRILLS, GLISSANDOS, SWOOPS, VIBRATO, STACCATO, etc.

EMPHASIZE PRETTY NOTES: 7ths, 9ths, and #4ths,

ALWAYS TRY TO BUILD YOUR SOLO. MAKE IT GO SOMEWHERE.

NOTE: Don't try to play everything you know in one solo. Take your time and plan ahead. Try to visualize your solo with ups and downs, fast sections and slow sections, loud and soft passages, tension and release sections. Aim at overall Tension-Release to your solo. Listen to jazz masters on recordings to get ideas and to wet your imagination. Music is for ears.

STARTING A PHRASE OR MELODY

1. At what part of your instrument will you begin your idea? Middle register, high, low?
2. How do you want to begin? Slowly, with held notes and use of space/rest? Quickly, with lots-of attention, motion, visibility? Moderately so as to suggest a searching mood?
3. What note of scale or chord do you want to begin with?
4. Once you be-in, do you want to ascend, descend, or stay in one general area, register?
5. Do you want to use pick-ups ... one, or more? If so, make sure they lead to the first strong beat!
6. Once you've begun your phrase, how long are you prepared to maintain your continuity, thoughts, ideas? One measure, two, four, eight? Have you thought of it?
7. What rhythm are you going to initially play? Does your mind already "HEAR" the notes/pitches in rhythm? Can you actually play them? Remember, your first phrase represents the first several words or idea of a sentence. Think clearly before you begin.
8. Chord tones (1, 3, 5, 7) are good notes to begin a phrases with. Know where they are on your instrument. 0
9. Is your initial idea coming from your mind or is it something that your fingers have picked out?
10. Windplayers ... be sure you've taken a good breath BEFORE you start each phrase. You need to SUPPORT the tone in order that it may effectively carry your musical thoughts to the mind of another.

PICK-UPS: The most used pickups are half-step, leading tone pickups such as: 7 to 1, #2 to 3, #4 to 5, 4 to 3. Some wholestep leading tones are: 2 to 1, 6 to 5. In a MINOR KEY we use: 4 to b3, 5 to 4, 2 to 1, b7 to 1 or 1 to b7, 5 to 6, 6 to maj.7th, 1 to 2, You can also use one chord tone to another such as 3 to 5, 7 to 5, 3 to 1, 1 to 3, 7 to 9 or 9 to 7. You can also use phrases such as 5, 6, 7, to 1; 5, 7, 9, to 1; b3, 3, 5, 6, to 1. The rhythm that you choose is also very important in making the pick-ups sound like they are LEADING TO the first DOWNBEAT.

ARTICULATIONS:

How To Better Express Yourself

One of the special features of jazz music is the articulation that the various players use in expressing themselves through their music. Some players enjoy using the standard swing style articulation very common to the Swing and Bebop eras, others use little articulation relying on legato or slurred phrases, some use staccato in their playing to add interest or emphasize certain notes or phrases.

Most all players eventually arrive at a style of articulation that is suitable for expressing themselves. Young players often struggle with getting the various muscles to respond at the precise time the fingers touch the keys, be it saxophone, trumpet, piano, guitar or whatever. Think of articulation as proper enunciation. No one enjoys listening to a speaker or a musician who cannot properly or effectively get his message across because his mind is not coordinated with his voice, lips, fingers, breath, etc.

Some players seem to have a natural ability to articulate in the jazz idiom. These players usually have listened to records and have etched into their minds the common, most used styles of articulation of the MAJOR jazz musicians. In incorporating these past styles of articulation into his own concept of playing music, he often will borrow a little here, a little there, and some of his own, and in the end be able to play out of several bags, as it were.

One major stumbling block that may be turned into a stepping stone is the player's use of too much tonguing tat tat tat or tut tut tut. Note: For keyboard, bass, guitar, and others, "tonguing" in this article can mean Attack or Emphasis. When you play several tongued notes in a row (one right after the other), the effect is a choppy feel. The music of the past forty to fifty years has been leaning toward a more relaxed, legato, smooth sound and flow. When I hear a player play phrases with the tat tat or tut tut articulation, I immediately feel this person has not had a chance (or has not taken the time) to hear jazz music as it has been played over the past forty years by the major jazz players. He should be tonguing legato style - tah tah tah or tu tu tu. Jazz is still basically an aural art form and the chances for you to be a jazz player without listening to the music that has come before you are very slim. With all the records on the market today there is no excuse to not be aware of the various schools of articulation and the main exponents.

When a note is tongued it naturally emphasizes that tone. It makes it stand out from the notes preceding it and the notes following it. By practicing the following exercises, listening to jazz musicians on record and in live performance who play the same instrument that you do, experimenting with articulation in general and keeping an open mind, I feel you can improve your playing and in the process be happier with the music you are playing. Good articulation definitely improves communication between performer and listener!

All of these exercises should be played with a metronome. Begin slowly and gradually increase the tempo. Don't increase the tempo too rapidly. Make sure you are listening to yourself as you play. The articulation has to become AUTOMATIC before it will begin to sound natural. Don't rush or force the exercises. Eventually, make up your own exercises and move the accented notes around in the scale. Gradually broaden the scale to include two octaves and then move on to include your entire instrument's range! I feel it is a good idea to begin with a fairly heavy accent, then medium, then light. For those who haven't done this before, they need to hear what an accent sounds like, and by playing heavy at first the idea seems to come in focus quicker.

Several players who I really made significant contributions in the flow of jazz articulation are: Cannonball Adderley, Sonny Rollins, Phil Woods, Freddie Hubbard, Clifford Brown, Miles Davis, John Coltrane, Dave Liebman, Wes Montgomery, Herbie Hancock, Lee Morgan, Ron Carter, Art Farmer, Lee Konitz, Charlie Parker, Clark Terry, J.J. Johnson, Slide Hampton, Woody Shaw, Kenny Dorham, McCoy Tyner, Ornette Coleman, Horace Silver and Joe Henderson. The list goes on and on, but when I think of these players and others I haven't mentioned, one of the outstanding features is their articulation and how it relates to the jazz tradition. Try to get the sound, Sound, SOUND in your ear!! You learn more about articulation from listening to music than from reading about it or even verbalizing. Opening your ears is one of the key ingredients in becoming a jazz musician.

You want to get to the point where you can instantly accent (heavy, medium, light, staccato, legato, breath, throat, stab, jab, etc.) any note or group of notes anytime you choose without disrupting the FLOW and FEEL of your melodic lines.

MOST IMPORTANT: Don't get stuck practicing the G major scale or the chromatic scale. Use (practice) these articulation exercises over ALL scales and chords in ALL keys. Remember, we improvise in all keys, not just the easy ones. Don't we?

Tongue every other note on the up beats.

Tongue the 4th note.

1. 

2. 

Chromatic — every other note on up beats.

3. 

Random tonguing

4. 

Random tonguing

5. 

Chordal exercises

6. 

A good order for practicing would look like this: Major, Dom. 7th, Minor (Dorian), Lydian dom., Lydian, Whole tone, Diminished, Dim. whole tone. Practice going from one scale right into the next like this:

Use any of the suggested articulations for the exercise below, or, change articulations every two bars.

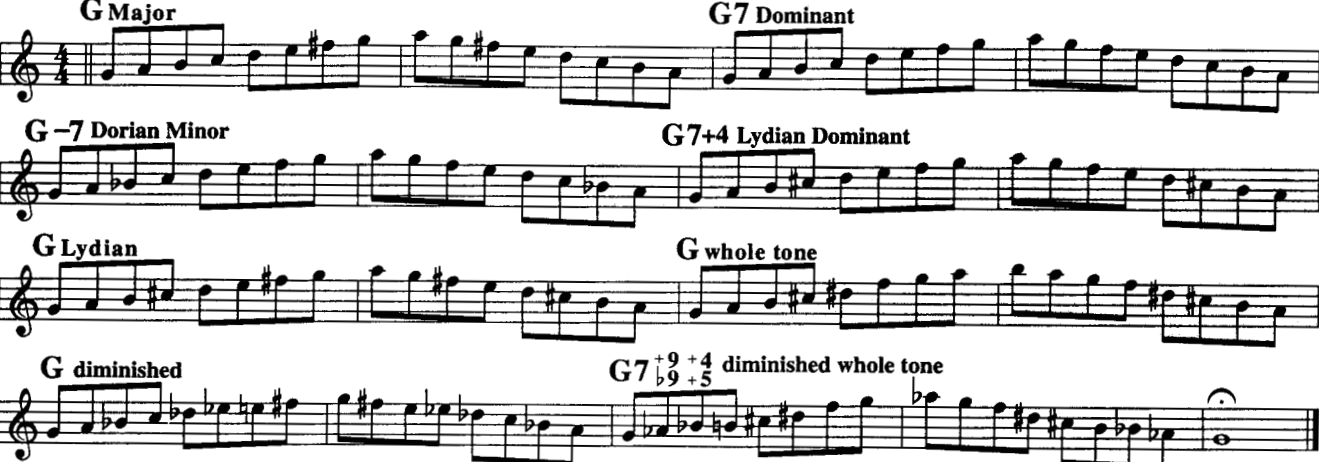
7. 

JAZZ RHYTHMS

The first note (It's a pick up) could always be left off without hurting the rest of the phrase.

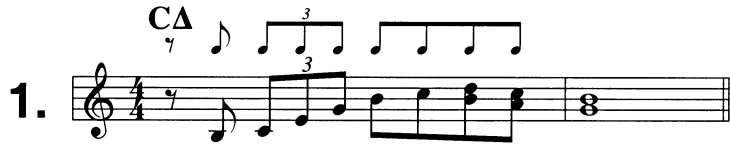
1. 















2.











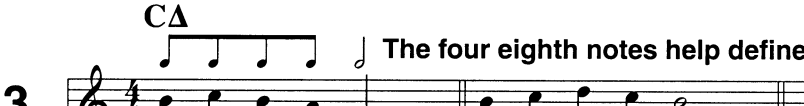

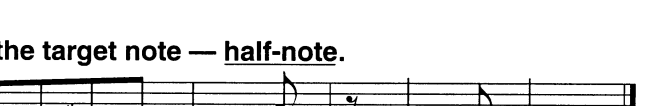

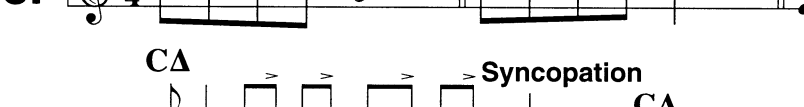

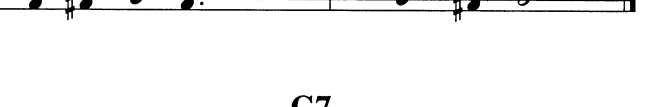

3.

4. 



5. 

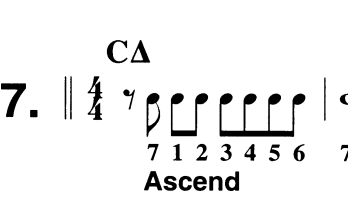

6.

7. 

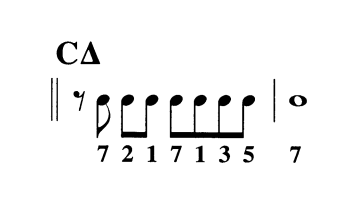

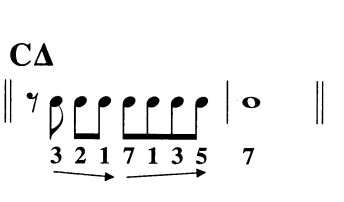



THE BLUES SCALE AND ITS USE

The blues scale consists of the following: Root, b3rd, 4th, #4th, 5th and b7th.

EXAMPLE: F blues Scale = F, Ab, Bb, B, C, Eb, F

When playing a twelve bar blues in the key of Bb, use the Bb blues scale: Bb, Db, Eb, E, F, Ab, Bb

The blues scale can also be used over minor chords when the minor chord is sounded for 2, 4, 8, or 16 measures or longer. EXAMPLE: If D minor is sounded for eight measures, you may use the D blues scale: D, F, G, Ab, A, C, D

When playing in minor tonalities you may choose to alternate between the dorian minor and the blues scale, both having the same root tone. EXAMPLE: If D minor is sounded for eight measures, play D minor (dorian) or play D blues scale or alternate between the two scale sounds.

The blues scale is used to convey a "Funky," "Down-Home," "Earthy" or "Bluesy" sound/feel. Rhythm and blues players use this scale extensively. Don't run it into the ground by overuse! Experiment with the blues scales listed below and apply them to recorded tracks on your play-a-long recordings.

After you become familiar with the blues scale as I have it listed, you may want to add tones to the scale which give the scale sound more variety. *Added tones are underlined.* EXAMPLE: F blues scale = F, G, Ab, A, Bb, B, C, D, Eb, F

This scale sounds strange when played straight up or down. Jazz players usually play bits and pieces of the scale or make up licks utilizing certain notes of the scale. You will eventually want to transpose this scale to all twelve keys for practice. For now, learn it in Bb and F concert.

THE TWELVE BLUES SCALES (Treble & Bass Clef)

The image displays the twelve blues scales in both treble and bass clefs. The scales are arranged in two main sections: Treble Clef (top) and Bass Clef (bottom). Each section contains three staves, one for each scale: C, Eb, and F. The notes are written in a sequence that demonstrates the scale's structure: Root, b3rd, 4th, #4th, 5th, and b7th. The scales are: C (C, Eb, F, F#, G, Ab, Bb), Eb (Eb, Gb, Ab, Ab#, Bb, C), and F (F, Ab, Bb, B, C, Eb). The notes are written in a sequence that demonstrates the scale's structure: Root, b3rd, 4th, #4th, 5th, and b7th. The scales are: C (C, Eb, F, F#, G, Ab, Bb), Eb (Eb, Gb, Ab, Ab#, Bb, C), and F (F, Ab, Bb, B, C, Eb). The notes are written in a sequence that demonstrates the scale's structure: Root, b3rd, 4th, #4th, 5th, and b7th. The scales are: C (C, Eb, F, F#, G, Ab, Bb), Eb (Eb, Gb, Ab, Ab#, Bb, C), and F (F, Ab, Bb, B, C, Eb).

THE CIRCLE or CYCLE of FOURTHS

The "CIRCLE of FOURTHS" can also be called the "Circle of Fifths" or just "The Cycle." Practicing the scales, chords, and ideas in general via the cycle has been a common practice routine for jazz musicians and is highly recommended. It is a disciplined way of working through all twelve keys. Plus, many bass root movements to jazz and pop songs move through sections of the cycle.

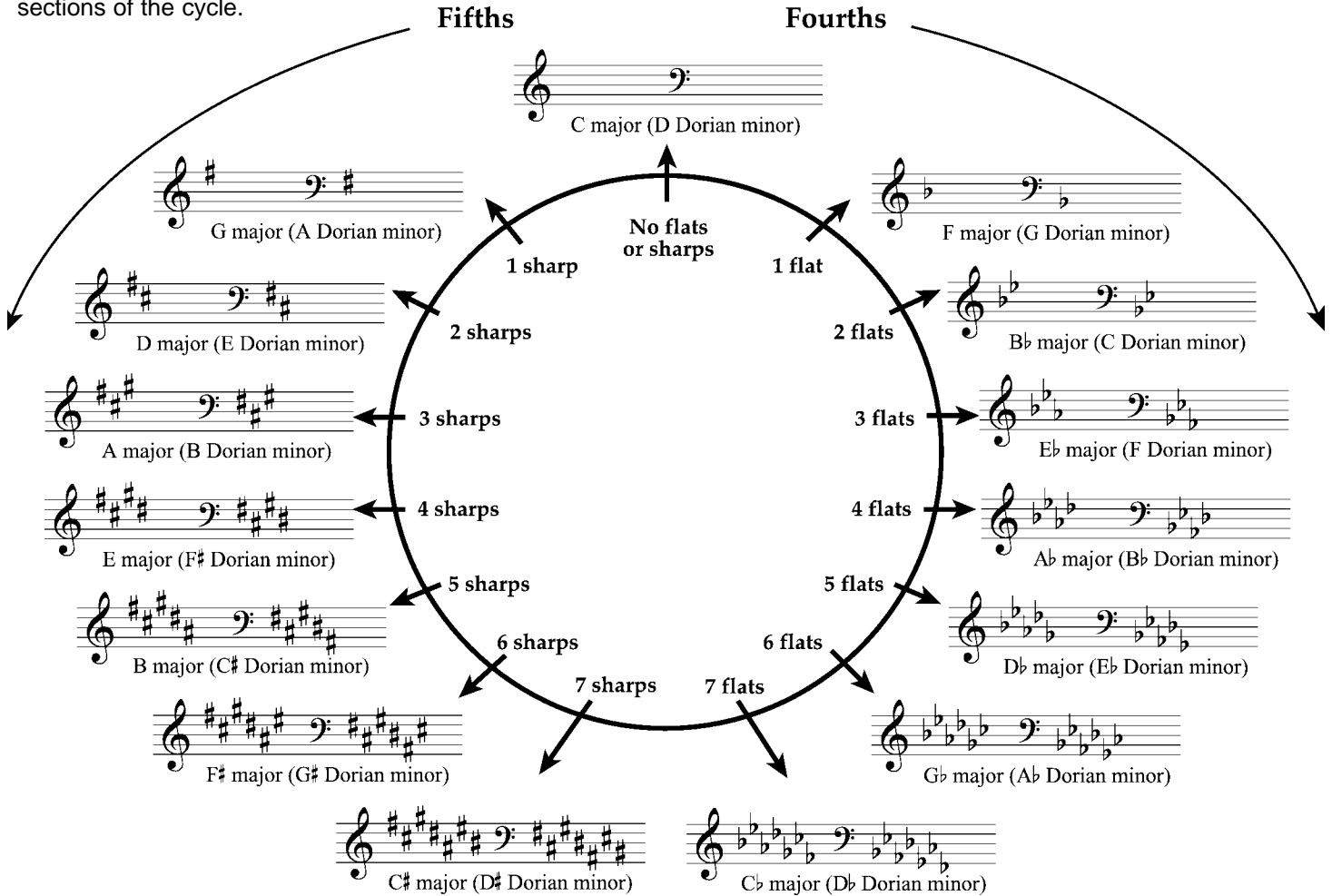

SCALES/MODES BASED ON MAJOR SCALE

Outlined below is a chart listing the seven scales (sometimes called Modes) that combine to form our major scale. The names in parenthesis are derived from the early Church modes (16th century) and several names are still in use today - Dorian, Lydian, Mixolydian.

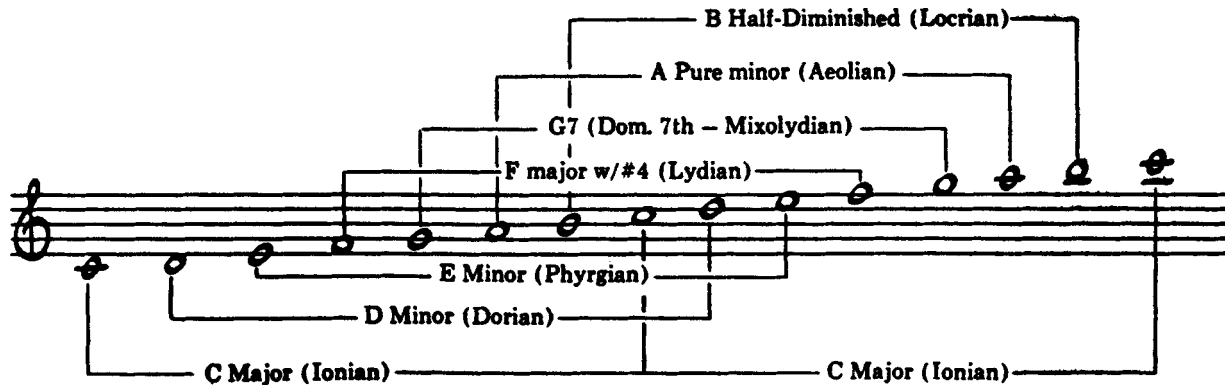

The interesting thing about the above scales is the fact they all share the same key signature, no flats or sharps! They are all related.

The scales which are used most often in Jazz are: Major, Dorian Minor, Dominant 7th (Mixolydian), Lydian, and Half -Diminished. Practice these first.

TRANSPOSITION CHART

C Concert Instruments: Trombone, Piano, Flute, Guitar, Oboe, Organ, Violin, Cello, Viola, Harp, C Melody Sax, C Trumpet, Bass Guitar, Bass Violin,

Bb Instruments: Trumpet, Cornet, Clarinet, Tenor Sax, Soprano Sax

Eb Instruments: Alto and Baritone Sax, Eb Clarinet,

NOTE: C Concert Instruments are non-transposing. They read their music as is. Bb instruments must play their notes UP a WHOLE STEP. This is called transposing up a step. Eb instruments must play their notes DOWN three half-steps (Minor third). This is called transposing a minor third.

If we had a musical phrase comprised of these notes, here is how they would be transposed;

C Concert Instruments play: C Eb G Bb A G F D Db Gb B E Ab

Bb Instruments play: D F A C B A G E Eb Ab C# F# Bb

Eb Instruments play: A C E G F# E D B Bb Eb Ab C# F

TWO INTERESTING SHORT STORIES

The following two stories are true. The Charlie Parker story is from a recorded interview with Leonard Feather. It is available in two versions, a short 5 minute version and a longer 15 minute version. The long version is from a record titled "Rappin with Bird." The label is MEEXA DISCOX and the record also contains eight songs by Bird.

The story about my friend John Welch was told to me by himself in 1976. After reading both stories I'm sure you'll see Bird's love of mankind and his willingness to be of help.

Charlie PARKER: "I knew how to play two tunes in a certain key, the key of D for saxophone (alto sax), F concert. I learned how to play the first eight bars of *Lazy River* and I knew the complete tune to *Honeysuckle Rose*. I never stopped to think about there being other keys or nothin' like that. So I took my horn out to this joint where a bunch of fellows I'd seen around were, and the first thing they started playing was *Body and Soul*, long-meter, you know. So, I go to playing my *Honeysuckle Rose* and there ain't no form of conglomeration, you know, so ... they laughed me off the bandstand ... they laughed at me so hard I was about 16 or 17 at the time. I never thought about there being any more keys, you know."

Jamey Aebersold: It is obvious from the above statements that Charlie Parker didn't know too much when he started out. Pretty much the same as most of us, I suspect. It is clear that Charlie Parker must have spent some time practicing the right things, listening to the right people, and in general, gathering as much knowledge about music as possible because he very shortly became a legend in his own time. I recommend reading the following books for more info on Charlie Parker's life (all are available from Jamey Aebersold Jazz - <http://www.jazzbooks.com>):

"Bird Lives" by Ross Russell

"Charlie Parker: His Music and Life" by Carl Woideck

"The Charlie Parker Companion: Six Decades of Commentary" by Carl Woideck

John Welch: "I was eighteen years old and very naive. I had studied arranging with Bill Russo. I went out to South Dakota to the University there to study music and found myself really unhappy with the situation. I wrote back and forth to Bill Russo and he got me in with Lennie Tristano in New York City for lessons. So, I took the bus to New York and my first weekend in New York I went down to the Village with my horn (trombone) to a club called the Open Door. There was a big sign on the window saying "Jam Session - Sunday Afternoon". This was Sunday afternoon so I went in with my horn and a group was playing a Blues in F. So I thought, well great, I enjoy playing Blues in F. I put my case on the table, took my trombone out and just walked right up and started to sit in with them. My playing at that point in my life was influenced by George Brunies, a Dixieland trombonist, so I started playing tailgate trombone with this group. They immediately brought Blues in F to a screeching halt and the piano player said, 'Cherokee in E' and took it at a tempo you wouldn't believe. I thought, well that's cool. I don't know *Cherokee* and I don't play very well in that key and I sure can't play that fast on trombone, so I'll sit this one out. So, I went back to the table and laid the horn in the case on the table and sat there. Everyone was looking at me as though cancer had arrived. Finally a guy in the audience came over and started unscrewing my horn, taking it apart and putting it away in the case. And he just looked down at me and said, 'Kid, you're obnoxious.'

"The band that day at the Open Door was Bud Powell, Max Roach., Charles Mingus, Miles Davis and none other than Charlie Parker himself!

"George Wallington was the fellow who came over to my table and dismantled my horn. And after he said that, I got the message!

"I realized I had really done something terrible. So they broke the set and Bird came over, came right straight over to my table. I remember him turning the chair around so he was leaning on the back as he faced me. Then he started talking to me. He said, 'Look kid, what you were doing didn't really fit in with this group, but you were doing it well. You really were laying it down. That's great! And you just keep going.'

"Bird was so compassionate in that moment with me when everyone else was ready to kill me. And this struck me very much. As a matter of fact, when I think of Charlie Parker, I would have to say he affected me much more as a human being in my reaction to other human beings at that moment than musically."

Jamey Aebersold: I feel that these two stories give us an excellent example of someone who seemingly, in jazz, has made it to the top but can still lean over and help the beginner and give encouragement when all else seems to fail. I would like to think one of the finest things jazz education can offer is the dissemination of valuable information to each corner of the musical world without any thought of return...

...The music of Charlie Parker has certainly done this...

Improvisation: PLAYING THE BLUES

by Jamey Aebersold

The Blues is a musical form that jazz musicians have always embraced because it allows them the opportunity to express emotion and everyday feeling and intellectual concepts which are often learned by studying another player's style and conception. Most beginning improvisers use the Blues as a springboard to other jazz forms. Many band directors and private teachers feel there is not too much to playing a decent blues solo. They feel that you learn the blues scales of the key the blues is in and just sorta' improvise what you feel over that scale sound. They probably think this is what they are hearing when they listen to jazz players on radio or records. I admit, they do hear some of that, but, if you check out the major jazz influences, you will begin to hear much more than just the blues scale.

In this article I would like to point out things to watch for in the blues that will make your playing more rewarding, convincing and musical. We should begin by asking you to sing (with your voice) several choruses of blues along with a record. A play-a-long recorded version of blues would be excellent because you don't have to listen to a soloist--you are the soloist. I suggest taping yourself so you can listen to yourself back and then, with your instrument in hand, try playing the phrases that you just sang! I contend that what we sing is often closer to the REAL YOU than what comes out of our instruments. On our instruments, we are inhibited and limited by our lack of knowledge of the instrument. If this is so, and I truly believe it to be so, the musician who knows his instrument well will have a much better chance of conveying the music that is contained within his brain to you the listener. When you are trying to play on your instrument what you just sung, be sure to play with the same inflections, articulation, dynamics, etc. If you are used to listening to jazz music, your vocal solo will probably be fairly recognizable to one who listens to this kind of music even though your voice may crack and sputter at times. Practice singing when you are driving by yourself or walking to school or to the office. Practice singing within your mind while lying in bed or waiting for a bus. Put your mind to use and it will instantly start paying you dividends in that you will be able to recognize phrases others play and this will enable you to put those ideas in motion on your chosen instrument. I have heard many fine jazz musicians say they have done much practicing away from their instrument. They mentally practice, and when they finally put their instrument in their hands it is as though they have already played the musical idea. In closing this paragraph on singing, I would like to point out that many musicians refer to a particularly beautiful musical phrase or solo as singing, even though the musician is playing an instrument. For example, "Coltrane was really singing."

The blues can have many different chord progressions. For instance, rock, gospel, soul, country and other simpler forms of blues music don't use the same chords as say, a Wayne Shorter blues, although they can if they want to. Usually, when you start beefing up the chords (harmony) one feels the song becoming more and more jazz influenced. When you start changing the chords to a gospel tune it just won't sound the same and the people who listen to that type of music will probably not be satisfied because the music is no longer what it used to be. Since jazz is an evolutionary art form the various chord modifications and alterations are welcomed and have become a part of the energy that has kept it alive.

The basic 12 bar blues originally used what we call three chords. They are: a dominant 7th built on the root, a dominant 7th built on the fourth, and a dominant 7th built on the fifth of the key you are in. Example: a blues in the key of F uses these three chords - F7, Bb7 and C7. The order of occurrence is in a twelve bar sequence and can look like this:

||F7 |F7 |F7 |F7 |Bb7 |Bb7 |F7 |F7 |C7 |Bb7 |F7 |C7 ||

There are variations ad infinitum to the chord progressions which can be used over a blues. A few of the more popular are as follows (key of F). NOTE: When two chord symbols appear in the same measure, each chord gets two beats.

- A.) ||F7 |Bb7 |F7 |Cmi F7|Bb7 |Bb7 |F7 |D7 |Gm9 |C7 |F7 |Gmi C7 ||
B.) ||F7 |Bb7 |F7 |Cmi F7|Bb7 |B^o7 |F7 |Ami7 D7 |Gm |C7 |Ami7 D7 |Gmi C7 ||
C.) ||F7 |Bb7 |F7 |Cmi F7|Bb7 |B^o7 |F7 |Ami7 D7 |Gm C7|Dbmi Gb7|F7 D7 |G7 C7 ||

One that Charlie Parker used on "Blues for Alice" uses descending root movement coupled with a cycle of fourths (upward). This is sometimes called Bird Blues:

||F |Emi A7 |Dmi G7 |Cmi F7 |Bb7 |Bbmi |Ami |Abmi |Gmi |C7 |Ami D7 |Gmi C7 ||

Enough for the various chord progressions that can be used. If you need more info, checkout Dan Haerle's book *Jazz- Rock Voicings for the Contemporary Keyboard Player* (available from Aebersold Jazz). He lists 17 different progressions ranging from very simple to very complex.

When beginning to practice the blues, I feel it necessary to get the feel of the roots, then the first five notes of each scale, then the triad (root, 3rd & 5th), and finally the entire scale. Here is what that would sound like:

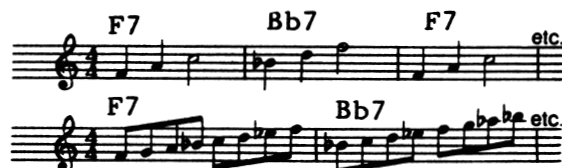
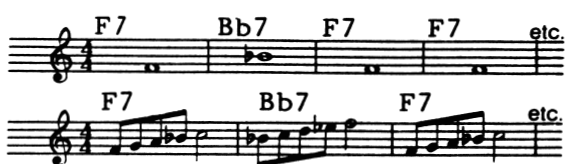

When two chords appear in one measure you have to alter the rhythm of the pattern or condense the number of notes in your pattern. No matter what song you are working on, use the above method for getting acquainted with the harmonic movement of the tune. I have heard two of the top jazz trumpet players in the country say this is the first thing they do when looking over a new piece of music that they are going to solo over. It makes good sense because it gets your ear accustomed

to the various scale and chord sounds in advance of the actual soloing. I strongly advise using this method of practice when approaching ANY new song.

The most important points in the blues progression, and these are often totally neglected by young improvisers, are the measures circled below:

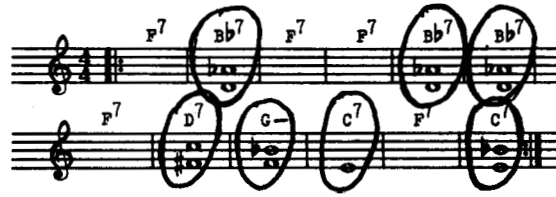

It might be good to improvise on the 3rd or 7th of each chord in order to get the sound and feel of the harmony in your mind. Using just the 3rd and 7th will sound like this (notice the half-step melodic motion from the first chord to the second):



I urge you non-piano players to practice the example above with your left hand, one octave lower than written, and try playing scalar exercises with the right hand so you can hear the basic harmony (3rd & 7th) in the left hand while running patterns or soloing in the right hand.

Most all good wind players have a knowledge of the keyboard and can play blues in several keys. It is much easier to solve harmonic problems while LOOKING at the piano keys than it is to see it on a sax finger table or trumpet valves.

It is a good idea to lead into the 3rd or 7th by half step. This strengthens the harmony. Notes that are good choices at the beginning of measures are listed below:



The Blues scale can, of course, be played at any time during the chorus. The notes of the blues scale often clash with the given harmony but that is what makes it sound like the blues! If it didn't clash in the beautiful way it does, we wouldn't call it a blues. Be careful not to confine your soloing to just the sound of the blues scale and in so doing overlook possibilities of variety by employing the other scales such as minor and dominant. The blues scale in the key of F is: **F Ab Bb B C Eb F**

CONCLUSIONS:

1. Play what you hear in your head. Use tape recorder to record your voice and transcribe it on your given instrument.
2. Sing with your voice while driving, showering, walking, etc. Think about the intervals you are singing. Are you singing bits and pieces of scales or chords?
3. Listen to jazz players play the blues.
4. Check out Volume 2 "Nothing But the Blues" play-a-long book and CD set. If you already have this volume, have you tried playing with all the tracks or have you just played the blues in Bb and F? Time to move on!
5. Remember leading tones are the 3rd and 7th usually. These tones should be emphasized in order to bring out the harmonic movement from chord to chord.
6. Use everything you have learned about melodic construction when playing on a blues. Don't just play on the blues scale. That sound can wear pretty thin in the hands of a novice but can sound fine when interspersed with phrases from the original harmony.
7. Transcribe a solo or a portion of a favorite solo and play it on your instrument with the same inflections as the recorded version. The jazz tradition has been passed down by imitation and you can benefit greatly by transcriptions.

WHAT DOES "TO HEAR" REALLY MEAN?

1. "To Hear" gives confidence in performance, practicing, teaching, composing and life in general.
2. "To Hear" gives more enjoyment as a listener. He/she hears at a deeper level of appreciation and understanding and this level grows as the years pass!
3. "To Hear" will earn you appreciation as teacher/performer because your playing and your teaching/coaching will reflect your EAR'S knowledge. You'll say and play things which reflect your knowledge and this can be extremely helpful to others in their musical quest.
4. "To Hear" instills independence, in a good sense. It helps dispell the "myths" of jazz and open one's creative channels. "To Hear" removes burdens and barriers.
5. "To Hear" makes one feel worthy of becoming part of the whole. It provides a certain amount of security and confidence which allows us to approach with assurance the springboard of one's "inner music." "To Hear" removes insecurity which allows the mind to function properly, in its natural state.
6. "To Hear" ultimately means freedom!

Variations On Blues

by Jamey Aebersold

My last article dealt with the Blues (12 bar Blues), so, I would like to follow up with variations on the blues progressions that have been in common use in the jazz idiom. The term "three chord songs" are usually referring to the simplest of blues progressions. If you are in the key of F the three chords which form the basis of the blues in that key are F7, Bb7 and C7. F7 is called a roman numeral I chord. The Bb7 is called the IV because it is built on the fourth scale step of the F7 scale and the C7 is called the V chord (usually called a V7 chord) because it is found on the fifth scale step of the F7 scale. A three chord tune could also be called a song that uses only I, IV, and V chords.

As blues evolved in the hands of the jazz musicians across the country by way of the radio and record player, more and more musicians played blues and naturally some would take liberties with the chord structure and alter the chords to match what they were hearing in their mind's ear. As the various alterations were passed from musician to musician they became part of the blues structure.

I have listed 17 different blues progressions found in Dan Haerle's book *Jazz/Rock Voicings for the Contemporary Keyboard Player*, published by Studio P/R, Inc.,

The progressions read from left to right! The ones at the top are the easier, simpler progressions. As you move down the page they become more altered and present more of a challenge to the up and coming jazz player. It is best to practice with one complete progression until you feel comfortable with it, then, move on to

the next one. You may also want to substitute a measure in one blues with the same measure in another blues below or above. Number 14 is one that Charlie Parker used on a blues called Blues for Alice and another called Laird Bird. Number 16 uses a steady stream of minor chords (II) moving to dominant 7th chords (V7) usually called II/V7-s or, a series of II/V's. Experiment with the various progressions using the exercises I showed you in the Nov. 1-Dec. 15 issue.

Begin slowly so you can hear the root progression clearly. In time your mind will remember it and you can move more rapidly. Try to memorize each progression as you are working on it. Memory is a key process in improvising! Listen to jazz players on records and see if you can hear when they are substituting chords or scales or licks or patterns over the basic three chord progression. The Masters do it all the time and with such ease that often our ears don't even realize they have deviated from the basic progression being played by the rhythm section. You may want to check out Volume 2 "Nothin' But Blues" in my play along book and record series. It contains eleven different blues progressions played by the rhythm section and you can play and practice along with them. Bass players and piano players can even turn off one channel of their stereo and substitute themselves for the player on the record. It is a great way to practice with a professional rhythm section.

In order to play blues you have to listen to people who play blues. Listen to the finest players, always!

EXAMPLES OF BLUES PROGRESSIONS																					
by DAN HAERLE																					
Read from left to right																					
measure no.	1	2	3	4	5	6	7	8	9	10	11	12									
1.	F7	F7	F7	F7	Bb7	Bb7	F7	F7	C7	C7	F7	F7									
2.	F7	F7	F7	F7	Bb7	Bb7	F7	F7	C7	Bb7	F7	C7									
3.	F7	Bb7	F7	F7	Bb7	Bb7	F7	F7	G7	C7	F7	C7									
4.	F7	Bb7	F7	F7	Bb7	Bb7	F7	D7	G7	C7	F7	C7									
5.	F7	Bb7	F7	F7	Bb7	Bb7	F7	D7	Gmi7	C7	F7	Gmi7 C7									
6.	F7	Bb7	F7	F7	Bb7	Eb7	F7	D7	Db7	C7	F7	Db7 C7									
7.	F7	Bb7	F7	Cmi7	F7	Bb7	Eb7	F7	Ami7	D7	Gmi7	C7	Ami7	D7	Gmi7	C7					
8.	F7	Bb7	F7	Cmi7	F7	Bb7	Eb7	Ami7	D7	Gmi7	C7	Ami7	D7	Gmi7	C7						
9.	F7	Bb7	F7	Cmi7	F7	Bb7	Bmi7	E7	F7	E7	Eb7	D7	Gmi7	C7	Bb7	Ami7	D7	Gmi7	C7		
10.	F M7	Emi7	A7	Dmi7	G7	Cmi7	F7	Bb7	Bb7	Ami7	D7	Abmi7	Db7	Gmi7	C7	Dbmi7	Db7	F7	D7	Gmi7	C7
11.	F M7	Emi7	Ebmi7	Dmi7	Dbmi7	Cmi7	Cb7	BbM7	Bbmi7	Ami7	Abmi7	Gmi7	C7	Ami7	Abmi7	Gmi7	Gb				
12.	F M7	BbM7	Ami7	Gmi7	Gbmi7	Cb7	BbM7	Bbmi7	Ami7	Abmi7	Gmi7	Gb7	F M7	Abmi7	Gmi7	Gb					
13.	F M7	BbM7	Ami7	Gmi7	Gbmi7	Cb7	BbM7	Bbmi7	Eb7	AbM7	Abmi7	Db7	GbM7	Gmi7	C7	Ami7	D7	Dbmi7	Gb		
14.	F M7	Emi7	A7	Dmi7	G7	Cmi7	F7	BbM7	Bbmi7	Eb7	Ami7	Abmi7	Db7	Gmi7	C7	Ami7	D7	Gmi7	C7		
15.	F M7	Emi7	A7	Dmi7	G7	Gbmi7	Cb7	BbM7	Bmi7	E7	Ami7	Abmi7	Db7	Gmi7	C7	Bb7	Ami7	D7	Gmi7	C7	
16.	Fbmi7	B7	Emi7	A7	Dmi7	G7	Cmi7	F7	BbM7	Bbmi7	Eb7	AbM7	Abmi7	Db7	GbM7	Gmi7	C7	Ami7	D7	Gmi7	C7
17.	F M7	Fbmi7	B7	EM7	EbM7	DbM7	BM7	BbM7	Bmi7	E7	AM7	Ami7	D7	GM7	GbM7	FM7	AbM7	GM7	Gb		

NOTE: Portions of these progressions could be combined with each other to create hundreds of slight variations of the above. Notice that practically all blues progressions follow a similar basic form, which is as follows: First 4 measures - I chord; Second 4 measures - IV chord (returning to a I chord or its substitute); Final 4 measures - V chord (or II-V substitute) returning to a I chord.

Reprinted from JIM PIERCE'S "Big Golden Trumpet Encyclopedia"
published by Charles Hansen Music & Books

VALUES

THE GREATEST HANDICAP --- FEAR
THE BEST DAY --- TODAY
EASIEST THING TO DO --- FIND FAULT
MOST USELESS ASSET --- PRIDE
THE GREATEST MISTAKE --- GIVING UP
THE GREATEST STUMBLING BLOCK --- EGOTISM
THE GREATEST COMFORT --- WORK WELL DONE
MOST DISAGREEABLE PERSON --- THE COMPLAINER
WORST BANKRUPTCY --- LOSS OF ENTHUSIASM
BEST TEACHER --- ONE WHO MAKES YOU WANT TO LEARN
GREATEST NEED --- COMMON SENSE
MEANEST FEELING --- REGRET AT ANOTHER'S SUCCESS
BEST GIFT --- FORGIVENESS
GREATEST KNOWLEDGE --- GOD
GREATEST THING IN THE WORLD --- LOVE

SUGGESTION: Put these values as a pin-up in your practice room.

Musical training
is a more potent instrument than any other,
because rhythm and harmony
find their way
into the inner places of the soul.
-- Plato

BILL EVANS - piano player

-- Evans forged a wholly original and completely personal approach to jazz piano. Evans once said: "... (Music) should enrich the soul; it should teach spirituality by showing a person a portion of himself that he would not discover otherwise. It's easy to rediscover part of yourself, but through art you can be shown part of yourself you never knew existed. That's the real mission of art. The artist has to find something within himself that's universal and which he can put into terms that are communicable to other people. The magic of it is that art can communicate to a person without his realizing it... enrichment, that's the function of music."

BEBOP CHARACTERISTICS

compiled by David Baker

1. COMPLEX HARMONIC IDEAS
2. LONGER MELODIC PHRASES USING ODD INTERVALS BUILT ON THE EXTENSION OF CHORDS (9ths, 11ths, 13ths, etc.) .
3. HARMONY GAINED EQUAL FOOTING WITH MELODY AND RHYTHM (WESTERN INFLUENCE).
4. A SOUND INSTRUMENTAL TECHNIQUE WAS MANDATORY.
5. A GOOD EAR AND A QUICK MIND WERE INDISPENSIBLE.
6. EIGHTH NOTES AND SIXTEENTH NOTES BECAME THE BASIC UNITS OF TIME.
7. HORNS AIMED FOR CLEAN, PIANO-LIKE EXECUTION.
8. PLAYERS FOLLOWED THE TREND TOWARD THE VIBRATOLESS SOUND (REDUCING THE LATITUDE AND FLEXIBILITY OF SOUND PRODUCTION IS ANOTHER WESTERN CONCEPT). AS A PRACTICAL CONSIDERATION, VIRTUOSITY DEMANDS AN UNENCUMBERED SOUND.
9. THE EMPHASIS WAS MORE ON CONTENT THAN ON SOUND.
10. COMPLEX CHORDS PROVIDED THE SOLOIST WITH A BROADER HARMONIC BASE, CONSEQUENTLY MAKING POSSIBLE A GREATER VARIETY OF NOTE CHOICES AND A HIGHER INCIDENCE OF CHROMATICISM.
11. CHORDS SERVED AS THE IMPROVISATIONAL REFERENTIAL RATHER THAN THE MELODY.
12. HOT IMPROVISATION (FAST, INTENSE, IMPASSIONED) WAS THE RULE.
13. COLLECTIVE IMPROVISATION WAS EXCLUSIVELY BETWEEN THE SOLOIST AND THE RHYTHM SECTION.
14. BEBOP WAS PRIMARILY A SMALL BAND MUSIC, BUT FOUND SOME EXPRESSION IN A FEW SELECT BIG BANDS.
15. A BROADENED CONCEPT OF CHORD SUBSTITUTION CAME INTO BEING; THIS HELPED TO PROVIDE A BROADER HARMONIC BASE.
16. THE MUSIC MOVED EVER CLOSER TO WESTERN EUROPEAN MUSIC BECAUSE OF ITS EMPHASIS ON HARMONY AND INSTRUMENTAL FACILITY AND ITS INCREASING USE OF OTHER WESTERN MUSICAL DEVICES.
17. THE ENTIRE LANGUAGE OF JAZZ WAS QUESTIONED, SUBTRACTED FROM, ADDED TO, PURGED, AND REAFFIRMED.
18. POLYRHYTHM BECAME AN IMPORTANT FACTOR AGAIN.
19. BEBOP TENDED TO CODIFY ALL THAT HAD GONE BEFORE; IT IS CONSIDERED THE COMMON PRACTICE PERIOD IN JAZZ.
20. UNISON MELODY STATEMENTS WERE THE RULE OF THUMB BECAUSE THE INCREASING HARMONIC COMPLEXITIES MADE COUNTERPOINT AND SECONDARY LINES LESS FEASIBLE.
21. THE BREAK AS A STRUCTURAL DEVICE REGAINED POPULARITY.
22. BEBOP PLAYERS MADE LIBERAL USE OF "QUOTES" OR INTERPOLATIONS FROM OTHER TUNES.
23. BEBOP REDUCED MELODY TO ITS ESSENTIALS. THERE WERE FEW BACKGROUNDS, SOME BRIEF INTRODUCTIONS AND ENDINGS, AND SOME UNISON INTERLUDES.
24. MELODIC LINES WERE SCALAR RATHER THAN CHORDAL.
25. MORE SOPHISTICATED SCALES WERE INTRODUCED INTO THE LANGUAGE; ONE EXAMPLE IS THE DIMINISHED SCALE (1 ♭2 ♭3 3 #4 5 6 ♭7 8)
26. THERE WAS MORE EFFORT TO MAKE THE SOLO LINES COHESIVE BY LINKING THEM TOGETHER WITH TURNBACKS, CYCLES, AND OTHER MUSICAL ADHESIVE DEVICES.
27. PIANO BECAME THE CENTER OF THE NEW EXPRESSION.
28. ASSYMETRICAL SOLO CONSTRUCTION BECAME A FACT.

A Short List of Bebop Players:

Charlie Parker, alto sax	Dexter Gordon, tenor sax
Dizzy Gillespie, trumpet	Mitt Jackson, vibes
Bud Powell, piano	Wynton Kelly, piano
Charlie Mingus, bass	Horace Silver, piano
Max Roach, drums	Art Blakey, drums
Thelonius Monk, piano	Jimmy Raney, guitar
Sonny Stitt, alto/tenor sax	Wes Montgomery, guitar
Clifford Brown, trumpet	Charles McPherson, alto sax
Wardell Gray, tenor sax	James Moody, tenor/alto sax
Al Haig, piano	Phil Woods, alto sax
Howard McGhee, trumpet	Cannonball Adderley, alto sax
Fats Navarro, trumpet	Miles Davis, trumpet
Red Rodney, trumpet	Lee Konitz, alto sax
J.J. Johnson, trombone	Gerry Mulligan, bari sax
Sonny Rollins, tenor sax	Ray Brown, bass

BEBOP SCALES

The "BEBOP" scale can be used over any quality ... major, minor, dom.7th or half-dim. It is probably used most often over Dom.7th and Dorian minor chord/scales.

C7 Bebop scale = C D E F G A Bb B-natural C -- This is also called the 7th scale.

Don't allow the B-natural to fall on a down-beat. It MUST fall on the up-beat: Beats 1, 2, 3, and 4 are down-beats. Good beginning/starting notes for ascending eighth-notes lines are: 1, 3, 5, b7. For descending eighth-note lines: the same as ascending: 1, b7, 5, 3. These are ALL chord tones. When you begin a phrase on the 2nd, 4th, or 6th note of the scale you must use a passing tone or chromaticism somewhere in the phrase in order to make the B fall on an upbeat. Be careful to use proper jazz articulation or you may negate the effectiveness of the Bebop scale/sound.

Doing the above will make your phrases sound natural and like what you hear on records.

BEBOP SCALES: MAJOR = 1, 2, 3, 4, 5, (#5), 6, 7, 1

DOM.7th = 1, 2, 3, 4, 5, 6, b7, (7), 1

MINOR = 1, 2, b3, (3), 4, 5, 6, b7, 1

HALF-DIM = 1, 2, 3, 4, 5, (#5), 6, 7, 1

The circled note is the extra, added tone.

PROPER USE OF THE BEBOP SCALE WILL INSTANTLY MAKE YOUR MUSICAL LINES MORE MATURE AND ALIVE.

Blues Progressions

from Volume 21 "Gettin' It Together" of the Aebersold Play-a-long Series

E♭ Instruments:

F BLUES (concert key)
8 choruses of 12 bar blues

30

D BLUES (IF CONCERT BLUES)

D Blues scale

D Blues scale may be played anytime during the D Blues

31

Bb BLUES (concert key)
10 choruses of 12 bar blues

G BLUES (Bb CONCERT BLUES)

G Blues scale

G Blues scale may be played anytime during the G Blues

Bass Clef C Instruments:

30

F BLUES - 8 choruses of 12 bar blues



F Blues scale

F Blues scale can be played anytime during F Blues

31

Bb BLUES - 10 choruses of 12 bar blues

Bb Blues scale

Bb Blues scale can be played anytime during Bb Blues

Jamey Abersold's

POINTS TO REMEMBER

Taken from his "Anyone Can Improvise!" Seminars

- Two factors that stop people from improvising are fear of getting lost and fear of playing a wrong note.
- Tape your own playing and listen to yourself. Don't be critical. Just Listen.
- Humor is an important part of creativity.
- TV kills imagination.
- Ignorance kills. So does smoking.
- Can you practice for one hour without interruption?
- If you don't think before you play a phrase, it is not improvisation - just an exercise.
- Sing! Sing! Sing!
- It is easier to sing what you hear in your head than it is to play it on your instrument - your objective is to be able to play what you hear in your head.
- Think each note before you play it.
- Did anyone ever die from thinking too much?
- The Blues is most commonly played in the keys of F and B flat by Jazz musicians.
- Don't practice the same thing forever - break new ground.
- Scales are REALLY IMPORTANT!
- Most music is grouped in 2, 4 and 8 bar phrases.
- Most drummers sing the melody to themselves to keep their place but they can learn to hear in phrases.
- The chromatic scale is your musical alphabet, know it from the lowest playable note on your instrument to the highest.
- There are only two whole-tone scales and only three diminished scales.
- Jazz players usually play eighth notes - play scales and exercises this way.
- Use Jazz articulation when playing chords and scales, not tonguing every note or slurring every note but something in between. Articulation is a key ingredient of your musical personality.
- Practice articulation - in 4 to 6 weeks you can transform your musical personality. Listen to the pros. When doing articulation exercises, play in a comfortable range where it is easy to finger. In this way you can concentrate on the articulation.
- One of the reasons you don't sound like the guys on record is because you haven't practice articulation.
- Play a solo along with a record in order to practice articulation - imitate the Jazz greats.
- Inspire - refers to the spirit within you - in spirit.
- Listen and lift ideas off records.
- LISTEN! -over and over and over! All the answers to your questions are on the records.
- Listen to Jazz every day.
- If you are well equipped technically you can take chances.
- Don't just use the play-a-long CD's to keep time, use them to learn to hear the TONALITY of each key that is played.
- In live Jazz there is an interaction between players.
- The best things in life are free and the free jazz handbook is one of them.
- It is great to play with people who are a little or a lot better than you - they will push you to improve.
- No one is a born player. Good instruments and teachers are important but the player makes himself.
- You can't imagine how much time and energy and thought Jazz musicians put into their craft.
- Conjure up your own harmony. Sit at a keyboard and explore.
- Play an arpeggio and keep it going in your head (mentally) while you sing a melody based on that chord.
- Sing a 12-bar blues (it's not that hard) just think and sing while driving or waiting for a bus.
- Move a blues up a half step and back down, just think of exercises - it will make it easier when you get to the practice room.
- Don't spend practice time on ear training, chord spelling and other exercises that you can do while commuting or in the shower. In this way you will get the most musical training out of your day.
- Charlie Parker practiced 11 to 15 hours per day for three years to four years.
- Ear Training - once you can hear what you are trying to play, things get a lot easier.
- Learn the distance between notes - intervals.
- Scales are based on the intervals of half and whole steps, chords are based on minor thirds (3 half steps) and major thirds (4 half steps). Learn to hear these intervals without batting an eye.

POINTS TO REMEMBER -- cont'd

- When you sing, visualize the keyboard. If you don't know what key you are in, just think in C. Do these important things away from the practice room - don't waste practice time.
- Whenever you see a chord symbol be aware that it implies a horizontal scale (1, 2, 3, 4, 5, 6, 7, 8) and a vertical chord (1, 3, 5, 7, 9, 11, 13, 1) most chords are built from every other note of the scale - but not all!
- A keyboard is very important for learning harmony and for hearing chord qualities. On a keyboard everything is laid out simply for you. You can get an electric keyboard for under \$100. They are very visual.
- Play "Mary Had A Little Lamb," "Happy Birthday" and "Twinkle, Twinkle" in twelve keys to get the music from your mind to your instrument.
- If you start or end a phrase on a chord tone (root, 3rd, or 5th) you can't go wrong.
- Practice a scale for two minutes solid, fast 8th notes, until it becomes automatic. Close your eyes, too.
- I have the notion that people learn instruments as an exercise in patience - to get to know themselves.
- Moving downward by half steps is easy to do with your voice but more difficult on your instrument.
- I, Jamey, know a lot and I can do a lot but I can't do it for you!
- If you THINK a lot about what you are doing, you will remember a lot.
- To learn a tune, memorize the changes one measure at a time. Play the scale for each chord then arpeggiate each chord; next, improvise. Memorize, memorize, memorize!
- If you have a doubt about anything in music, find a piano and play it. Does it sound like what you hear on record?
- If you want to put a 4th in a major chord you must raise it (F#/C) Lydian, or play the regular 4th as a passing tone.
- Perhaps the major scale should have been constructed this way: CDEF#GABC Lydian. Think sharp 4 not flat 5.
- On Piano: Learn two note voicings with the right hand (3rd and 7th can tell you everything that is going on).
- If you are a non-keyboard player just play the roots with your left hand - memorize the roots to songs.
- III VI II V I (Turnaround) Turnarounds get you back to the top of the tune.
- A piano player (when playing for rhythm section) should play in the register from an octave below middle C to an octave and a half above middle C, so as not to crowd the horn players in the upper register.
- Jazz history has a protocol - don't overplay.
- Watch how independent a piano player's left hand is while they solo with the right hand.
- By using different voicings you can play chords without moving up and down the keyboard.
- Practice scales and exercises in time and without stopping - this is how we play music, after all.
- When you voice a chord on guitar or keyboard, you don't have to play a lot of notes to sound good.
- B half diminished: BCDEFGAB. The C natural does not always sound so great so use it as a passing tone on an upbeat - You can play sharp 2 anytime (C#).
- SEQUENCE means to repeat a chord, a chord pattern or a melodic phrase in a different key.
- Spend 15 or 30 minutes per day with a keyboard even if you are a horn player.
- Jazz uses a few things over and over, it is a great relief to realize this - things do not seem so vast.
- There are only twelve keys, we play mostly in six of them (C, Bb, Eb, Ab, F and G) not so often in (B, E, F#, C#, E and A) but jazz tunes modulate like crazy - we end up in all keys at one point or another.
- A key signature is for the melody (notational convenience); it can have very little to do with the harmony (key).
- Look at the last chord in a tune, (or the next to the last measure) if it is major and lasts for a full bar, that is probably the key the tune is in. Especially if the first chord is similar.
- This is my college education - my pitch pipe!
- A chromatic pitch pipe gives you independence - you can learn the musical universe on your own.
- Use a pitch pipe to learn all the intervals within an octave - don't use practice room time for ear training - do it on the fly (hustle while you wait).
- Point to the "paper keyboard" and sing the notes as you point to different keys - after a few bars, check your accuracy with a pitch pipe.
- Grab a tune and just sing the roots.
- Don't just sing a scale, visualize the keyboard or your instrument, keep checking yourself with the pitch pipe. Next change key and do it again.
- Write a tune!
- It's not hard to write a tune, Steve Allen wrote 450 tunes with lyrics in just one sitting, one day.
- Written music is a crutch! Memorize, instead.
- Transposed parts are a crutch! In the old days there were no fake books, we transcribed everything from records and learned to transpose in the process. We used our ears and memory.

POINTS TO REMEMBER -- cont'd

- A good musician has a large repertoire in his head - he doesn't rely heavily on books.
- Music doesn't care who plays it.
- "Play what is there, we don't need to hear you lying" - Art Blakey
- When you finally play what is in your head, you will meet yourself for the first time.
- "It takes a long time to play like yourself" - Miles
- You can answer all your questions about jazz by listening: LISTEN! LISTEN! LISTEN!
- When you solo, use repetition and sequence, don't ramble. This allows the listener to anticipate what you are doing. This is known as thematic improvisation. Sonny Rollins' solos are a great example of this.
- The interval from B flat to E contains three tones (Bflat =>C=>D==>E) hence the name tritone.
- Very few adults take the time required to learn to play jazz (or even simply to listen to it!)
- If you want to keep the harmony outlined, play chord tones on beats one and three.
- The root third, fifth and seventh outline the harmony.
- A characteristic of Bebop solos is that they outline harmony very explicitly.
- Do you have a dozen tunes memorized? Know the melody and the form, be able to write out the chord progressions (Jamey has 1000 tunes memorized!)
- Learn some tunes, and listen to music throughout the day to keep them in your head.
- Put your tune repertoire in a notebook so you can review it.
- As an exercise in getting your solos to sound like what you hear in your head, put a play-a-long CD on and play four bars, then sing four bars, then play four bars ... then sing, etc.
- To execute your objective: Think it - Say it - Do it!
- The average person has to learn to play in time - it does not come naturally. You can use a metronome.
- In jazz, time is very important - use a metronome for practice. When you practice scales and chords always practice in time and use proper articulation.
- Start to improvise early in your musical education.
- I'm interested in seeing people play music throughout their entire life.
- If you don't improvise every day what is the point of practicing scales and chords?
- Music is supposed to be fun - have fun when you practice.
- When I asked some musicians how much of the day they spend thinking music they responded 24 hours per day!
- When you solo, look for common tones between changes, anticipate, think ahead. Think about the subsequent chord scale while you are improvising on the current one. It is not that hard, do it soon to prove this to yourself. This is called "playing across the bar lines."
- The melody to a song is called the head.
- Obstacles are opportunities. Turn stumbling blocks into stepping stones.
- Don't approach your practice as if you have to learn a great deal of information and acquire a great deal of skill so you then can play - instead start playing NOW! ! !
- If you play straight 8th notes you can play the bebop scale for a measure and end on the degree of the scale that you started on (most of our scales have seven notes and don't work out this way.) The Bebop scale gives you 8 notes per measure instead of seven when played in 8th notes.
- The effective use of the Bebop scale often separates those who can play from those who are trying to play.
- Don't forget that a chord symbol implies a scale (horizontal) and a chord (vertical).
- You can't listen to records enough - it is so very important!
- If you don't have a good sound who is going to care about what you have to say - even if you have great ideas.
- To find a lowered 7th just go down a whole step from the root.
- To find a sharp 9 go up a minor third from the root.
- The 3rd and 7th are the most important notes in outlining chord quality. The root is always assumed.
- Tape yourself and listen back objectively. Don't be afraid to hear yourself as others hear you.
- In 4/4 time, if you want to give harmonic stability, play chord tones (1,3,5, and 7) on beats one and three.
- Dave Brubeck's "Take Five" (in 5/4) is really bars of 3/4 followed by bars of 2/4. 12 3 12, 1 2 3 1 2, 1 2 3 1 2
- Lydian is a favorite substitute for major (especially in tune endings).
- Chuck Sher's New Real Books are accurate.
- The tunes that jazz players like and that are challenging often have pretty chord tones in the original melody. Pretty notes can be the major 7th, 9th or #4 in MAJOR; b7, 9 and 4 in MINOR.
- Strive to solo on a tune, without playing the melody and without a rhythm section, in such a way that a listener could name the tune (this means you are doing a good job of outlining the harmony).
- ***The music is between your ears...***

II/V7/I PROGRESSION with emphasis on 7th resolving to 3rd

1. D-7 G7 C 2. D-7 G7 C

3. D-7 G7 C 4. D-7 G7 C

5. D-7 G7 C 6. D-7 G7 C

3 7 3 Anticipated

1. E-7 A7 D 2. E-7 A7 D

3. E-7 A7 D 4. E-7 A7 D

5. E-7 A7 D 6. E-7 A7 D

3 7 3

1. B-7 E7 A 2. B-7 E7 A

3. B-7 E7 A 4. B-7 E7 A

5. B-7 E7 A 6. B-7 E7 A

3 7 3

1. D-7 G7 C 2. D-7 G7 C

3. D-7 G7 C 4. D-7 G7 C

5. D-7 G7 C 6. D-7 G7 C

3 7 3

Blues

- ① "F" BLUES - 2-note voicings. ② "F" BLUES - 2-note voicings.
 ③ "F" BLUES - 3-note voicings. ④ "Bb" BLUES - 2-note voicings. ⑤ "Bb" BLUES
 2-note voicings. ⑥ "Bb" BLUES - 3-note voicings. ⑦ "Bb" BLUES - 4-note voicings.

Play the ROOT in the left hand to help get the sound of the Blues in your ear/mind.

These voicings will eventually end up being played in the Left Hand so the Right Hand can improvise or practice scales, chords, patterns, etc.

① F7 Bb7 F7 C- F7 Bb7 Bb7 F7 D7

G- (G7) C7 F7 C7 ② F7 Bb7 F7 C- F7

Bb7 Bb7 F7 D7 G- (G7) C7 A- D7 G- C7

③ F7 Bb7 F7 C- F7 Bb7 Bb7 F7 D7 D7#9

G- C7 A- D7 G- C7 ④ Bb7 Eb7 Bb7 Bb7

Eb7 Eb7 Bb7 G7 C- (C7) F7 Bb7 F7

⑤ Bb7 Eb7 Bb7 Bb7 Eb7 Eb7 Bb7 G7 C- (C7) F7 Bb7 F7

⑥ Bb7 Eb7 Bb7 Bb7 Eb7 Eb7 Bb7 G7b9 C- (C7) F7 Bb7 F7

⑦ Bb7 Eb7 Bb7 Bb7 Eb7 Eb7 Bb7 G7 (G7b9) C- (C7) F7 Bb7 F7

MAJOR AND DOMINANT 7TH

MAJOR - thru Cycle - 3rd and 7th.

CΔ FΔ BbΔ EbΔ AbΔ DbΔ GbΔ BΔ EΔ AΔ DΔ GΔ CΔ

1

MAJOR - thru Cycle - 3rd and 7th.

CΔ FΔ BbΔ EbΔ AbΔ DbΔ GbΔ BΔ EΔ AΔ DΔ GΔ CΔ

2

MAJOR - up chromatically. 3rd and 7th.

CΔ DbΔ DΔ EbΔ EΔ FΔ F#Δ GΔ AbΔ AΔ BbΔ BΔ CΔ

3

MAJOR - down chromatically. 3rd and 7th.

CΔ BΔ BbΔ AΔ AbΔ GΔ F#Δ FΔ EΔ EbΔ DΔ DbΔ CΔ

4

DOMINANT 7ths - thru Cycle. 3rd and 7th.

C7 F7 Bb7 Eb7 Ab7 Db7 Gb7 B7 E7 A7 D7 G7 C7

5

DOMINANT 7ths - thru Cycle. 3rd and 7th.

C7 F7 Bb7 Eb7 Ab7 Db7 Gb7 B7 E7 A7 D7 G7 C7

6

DOMINANT 7ths - thru Cycle. 3 note voicings.

C7 F7 Bb7 Eb7 Ab7 Db7 Gb7 B7 E7 A7 D7 G7 C7

7

DOMINANT 7ths. Cycle. 4-note voicings.

C7 F7 Bb7 Eb7 Ab7 Db7 Gb7 B7 E7 A7 D7 G7 C7

8

PIANO VOICINGS

- ① II - V7 - I ② II - V7 - I ③ MAJOR, DOM.7TH, II - V7 - I

①

C- F7 BbΔ Bbb B- E7 AΔ A6 Bb- Eb7 AbΔ Ab6 A- D7 GΔ G6

Ab- Db7 GbΔ Gbb G- C7 FΔ F6 F#- B7 EΔ E6 F- Bb7 EbΔ Eb6

E- A7 DΔ D6 Eb- Ab7 DbΔ Db6 D- G7 CΔ C6 Db- Gb7 BΔ B6

②

C- F7 BbΔ Bb- Eb7 AbΔ Ab- Db7 GbΔ F#- B7 EΔ

E- A7 DΔ D- G7 CΔ C#- F#7 BΔ B- E7 AΔ

A- D7 GΔ G- C7 FΔ F- Bb7 EbΔ Eb- Ab7 DbΔ

③

CΔ C7 C- F7 BbΔ Bb7 Bb- Eb7 AbΔ Ab7 Ab- Db7 GbΔ Gb7 F#- B7

EΔ E7 E- A7 DΔ D7 D- G7 CΔ DbΔ Db7 C#- F#7 BΔ B7

B- E7 AΔ A7 A- D7 GΔ G7 G- C7 FΔ F7 F- Bb7 EbΔ Eb7 Eb- Ab7 DbΔ

Most standards and Blues use the harmonic progression called II/V7 or II/V7/I. These pages list the most common keyboard voicings, and they are played by professionals everywhere. Memorize these and you'll quickly find they are the meat and potatoes of popular American music. (Voicings taken from the Vol. 3 "II/V7/I" Aebersold Play-a-long book).

PIANO VOICINGS

II-V7-I ALL MAJOR KEYS

II V7 I

II V7 I

II V7 I

II V7 I

II V7 I

I-V7-I ALL MAJOR KEYS (inversions)

II V7 I

II V7 I

II V7 I

II V7 I

II V7 I

II V7+9 I

Ø-V7+9-I ALL MINOR KEYS

Handwritten musical notation for the first system, showing chord progressions in four systems of two staves each. The notation includes chord symbols such as Dø, G7+9, C-, C-, Cø, F7+9, Bb-, Bb-, Ebø, Eb7+9, Ab-, Ab-, Abø, Db7+9, Fø, F-, Eø, A7+9, D-, D-, Eø, Ab7+9, Cø, Cø, Cø, Fø, Fø, B-, B-, Bø, Eb7+9, A-, A-, Aø, Db7+9, G-, G-, Gø, C7+9, F-, F-, Fø, Eb7+9, Eb-, Eb-, Ebø.

Annotations include "PLAY DOWN 8/16" and "PLAY DOWN 8/16" written above the treble clef staves in the first and third systems.

II V7+9(b9) I

Ø-V7+9-I ALL MINOR KEYS (inversions)

Handwritten musical notation for the second system, showing chord progressions in four systems of two staves each. The notation includes chord symbols such as Dø, G7+9, C-, C-, Cø, F7+9, Bb-, Bb-, Ebø, Eb7+9, Ab-, Ab-, Abø, Db7+9, Fø, F-, Eø, A7+9, D-, D-, Eø, Ab7+9, Cø, Cø, Cø, Fø, Fø, B-, B-, Bø, Eb7+9, A-, A-, Aø, Db7+9, G-, G-, Gø, C7+9, F-, F-, Fø, Eb7+9, Eb-, Eb-, Ebø.

Annotations include "PLAY DOWN 8/16" written above the treble clef staves in the second and fourth systems.

The next few pages are used for study and practice at my Summer Jazz Workshops. Let me encourage you to try them on your own. If you do not have a teacher or band director who can help you correct your exercises when you're done, feel free to mail them to us and we will correct them and mail them back to you. -- **Jamey Aebersold**

H = Half Step, W = Whole Step, -3 = Minor Third (3 half steps)

Major scale = W W H W W W H

Minor scales = W H W W W H W

Dominant 7th scales = W W H W W H W

Half-Diminished scales = H W W H W W W

Half-Diminished #2 scales = W H W H W W W

Lydian = W W W H W W H (Major with #4)

Whole tone scales = W W W W W W

Dim. scale. = W H W H W H W H (begin with W)

Dim scales = H W H W H W H W (begin with H)

Dim. whole tone scales = H W H W W W W

Blues scales = -3 W H H -3 W

Lydian dominant = W W W H W H W

**For additional study I highly recommend Dan Haerle's book "The Jazz Language."
[# and + means to raise 1/2 step. b or - means to lower 1/2 step. -3 means 3 half steps.]**

WRITE THE FOLLOWING SCALES USING THE ABOVE WHOLE AND HALF STEP SEQUENCES:

1. Bb
2. Ab7
3. B-7
4. B \emptyset
5. D-
6. C#7
7. F#-7
8. E \emptyset
9. F-7
10. D7
11. G-
12. C7
13. F
14. A \emptyset #2
15. Bb major #4
16. Ab-
17. Eb7
18. E-
19. B7
20. C7#4

Jamey Aebersold Theory —Summer Jazz Workshops

WRITE THE SCALES TO THE FOLLOWING CHORD SYMBOLS. WRITE THE NAME OF THE SCALE TO THE LEFT, ALSO.

USE PENCIL

SCALE NAME:

1. A7#4
2. B- \triangle
3. C7+9
4. Bb \triangle #4
5. D \emptyset
6. Ab \triangle #4
7. C \emptyset #2
8. F \triangle #4,#5
9. Bb- \triangle
10. E7#4
11. F7+5
12. Eb7 #4, #5
13. A \triangle #4
14. Db7b9
15. B7b9
16. G- \triangle
17. C7b9
18. G \emptyset
19. D- \triangle
20. A7#9

Jamey Aebersold Theory - Summer Jazz Workshops

USE PENCIL

1. The 3rd tone of the Eb major scale is _____
2. The 4th tone of the A- scale is _____
3. The 6th tone of the Bb7 scale is _____
4. The 5th tone of the Ab-7 scale is _____
5. The 3rd tone of E-7 scale is _____
6. The 7th tone of Ab major scale is _____
7. The 2nd tone of F7 scale is _____
8. The 7th tone of E7 scale is _____
9. The 2nd tone of F#7 scale is _____
10. The 4th tone of F#-7 scale is _____
11. The 6th tone of Eb-7 scale is _____
12. The 7th tone of D-7 scale is _____
13. The 5th tone of Db7 scale is _____
14. The 3rd tone of B7 scale is _____
15. The 2nd tone of Gb major scale is _____
16. The 8th tone of B-7 scale is _____
17. The 4th tone of the Bb-7 scale is _____
18. The 1st tone of the F#7 scale is _____
19. The 5th tone of the E7 scale is _____
20. The 7th tone of the F-7 scale is _____
21. The 3rd tone of the G7 scale is _____
22. The 3rd tone of the F#-7 scale is _____
23. The 4th tone of the D7 scale is _____
24. The 6th tone of the Eb7 scale is _____
25. The 7th tone of the Db7 scale is _____
26. The 7th tone of the E major scale is _____
27. The 6th tone of the A7 scale is _____
28. The 5th tone of the Db-7 scale is _____
29. The 7th tone of the B7 scale is _____
30. The 4th tone of the Bb-7 scale is _____
31. The 8th tone of the Eb-7 scale is _____
32. The 2nd tone of the B major scale is _____
33. The 7th tone of the C-7 scale is _____
34. The 6th tone of the Gb7 scale is _____
35. The 9th tone of the Ab major scale is _____
36. The 9th tone of the E-7 scale is _____
37. The 9th tone of the B7 scale is _____
38. The 4th tone of the F7 scale is _____
39. The 3rd tone of the Ab-7 scale is _____

II V7 I

II V7 I sequences in major keys/II V7 I sequences in minor keys

I have listed one of the three chord symbols and you are to fill in the other two chord symbols. The exercise reads from left to right. When in a minor key the II chord becomes half-diminished, and the V7 chord is usually altered with b9 and +9 and/or +5 or +4.

MAJOR KEYS

	II	V7	I
1		A7	
2	D-		
3		Bb7	
4			Ab
5		G7	
6	C-		
7			Gb
8	Ab-		
9		Db7	
10		E7	
11			C [△]
12		B7	
13	F-7		
14			G
15	C-		
16		F7	
17	B-		
18			A [△]
19	Eb-		
20		D7	

MINOR KEYS

	(half-dim.) II	V7 (altered dom.)	I (minor)
1	D [∅]		
2		A7+9	
3		D7+9	
4	E [∅]		
5			Ab-
6		C7b9	
7	F [∅]		
8	C [∅]		
9			Bb-7
10		G7b9	
11	C# [∅]		
12			G-7
13		F7+9	
14			A-7
15		C#7+9	
16	A [∅]		
17			Eb-7
18		B7b9	
19	B [∅]		
20			Db-

The distance from the root of the II chord to the root of the V7 chord is a Perfect 4th. A Perfect 4th interval is equal to 5 half-steps. The distance from the root of the V7 chord to the root of the I chord is a Perfect 4th, also. Try to memorize the sequences intact: II V7 I. Think of each chord as being related to the chord on either side of it. Remember, the scales which comprise II V7 I in major keys contain the same key signature.

II V7 I

Example: D- G7 C all contain no sharps and no flats

Answer the following questions as quickly as possible:

1. The +9 of B7+9 is _____
2. The diminished scale has how many different tones? _____
3. How many notes are in a whole tone scale? _____
4. When you see the chord symbol C7+5, is the 4th also raised? _____
5. How many half steps equal a perfect 4th? _____
6. Write the cycle of fourths beginning with D, G, C, _____
7. Where does a V7 chord usually resolve to? _____
8. Can a II chord sometimes be a dominant 7th instead of minor? Yes ____ No ____
9. Write a Bb Blues progression. Be sure to use a II/V7/I in the last four bars.

10. Name the b9 and the +9 in the key of Bb. _____
11. F# is the raised 4th of what scale? _____
12. If Db is I, what is II? _____
13. Write the chord symbols for II/V7/I in Eb-: _____
14. How many different major scales are there? _____
15. How many different tones are in the chromatic scale? _____
16. What two tones in the dominant 7th chord form the Tritone? The _____ & _____
17. What type (quality) chords are found in the regular Blues progression.

18. How many bars in a typical Blues? _____
19. What two keys is the Blues most often played in? _____ & _____
20. What part of your body do you need to use more often in order to become a better musician?
